

# Flymo

 Electrolux

# Micro Lite

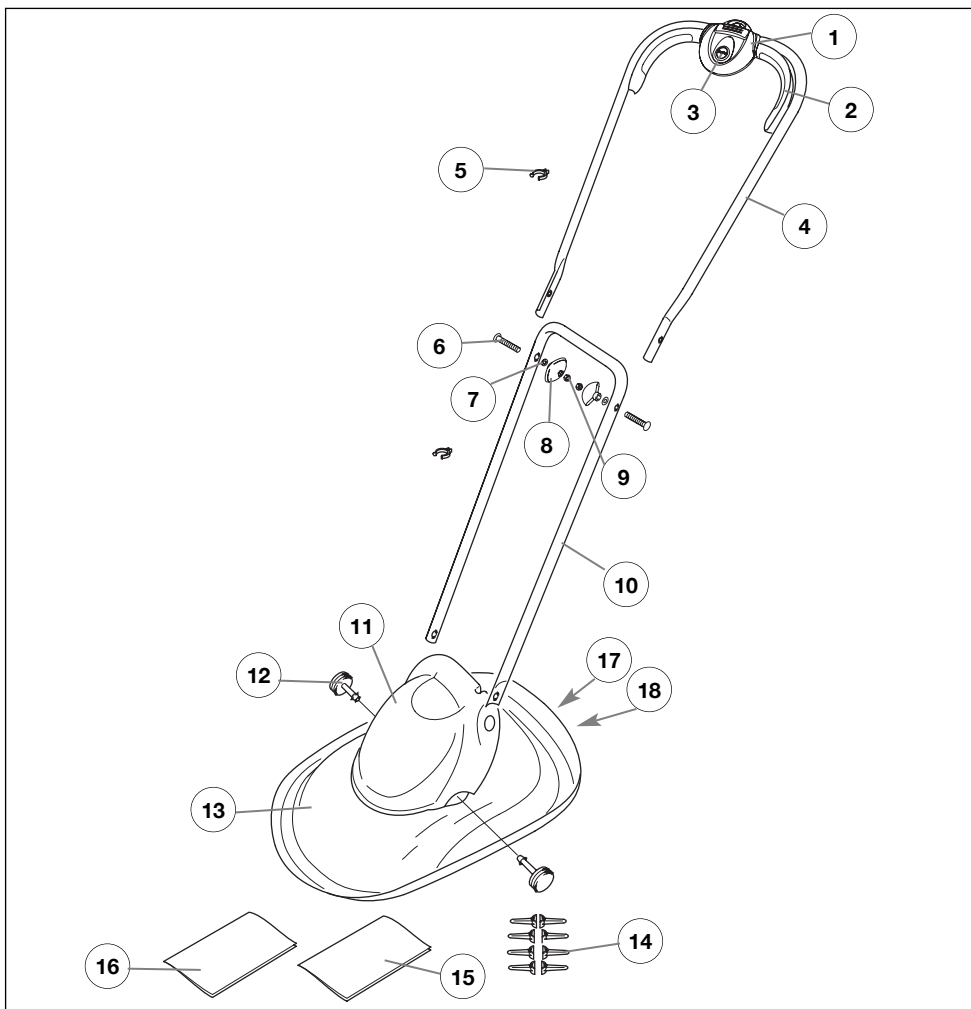

**GB** CONTENTS

**DE** INHALT

**FR** TABLE DES MATIÈRES

**NL** INHOUD

**NO** INNHOLD

**FI** SISÄLTÖ

**SE** INNEHÅLL

**DK** INDHOLD

**ES** CONTENIDO

**PT** LEGENDA

**IT** INDICE CONTENUTI

**HU** TARTALOMJEGYZÉK

**PL** ZAWARTOSC KARTONU

**CZ** POPIS STROJE

**SK** OBSAH

**SI** VSEBINA

**HR** SADRŽAJ

**BA** SADRŽAJ

**CS** САДРЖАЈ



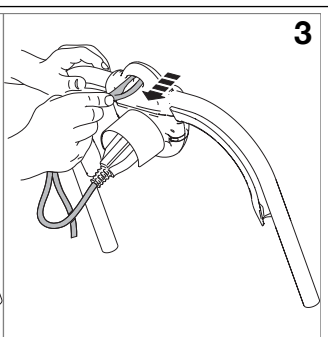
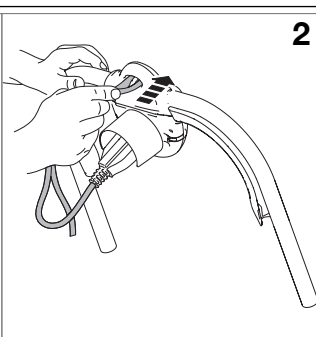
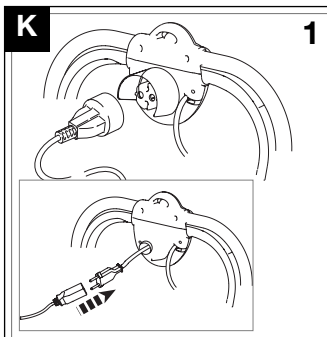
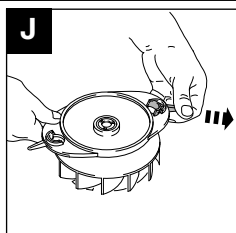
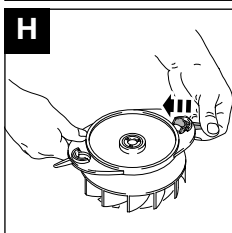
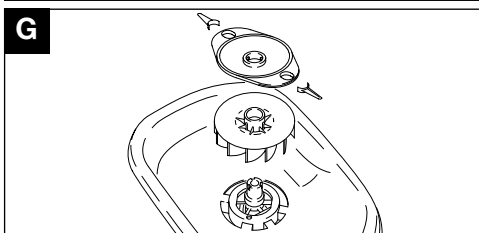
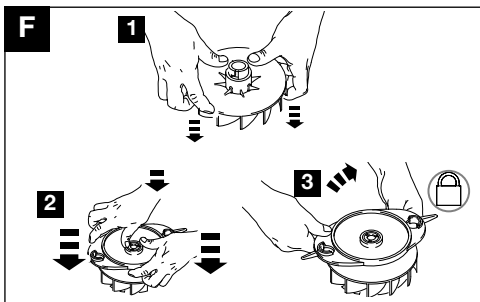
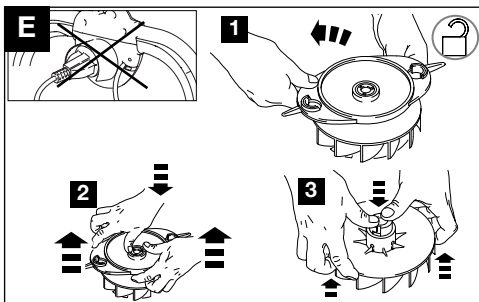
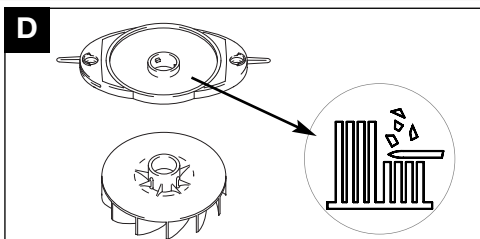
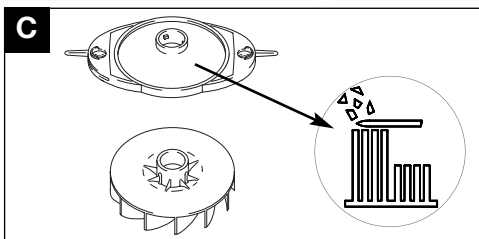
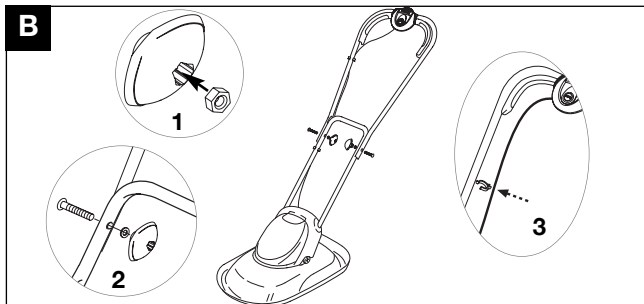
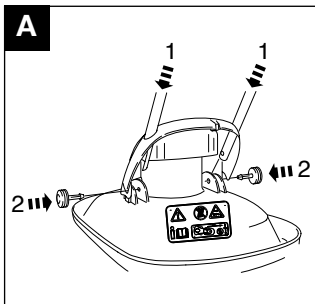

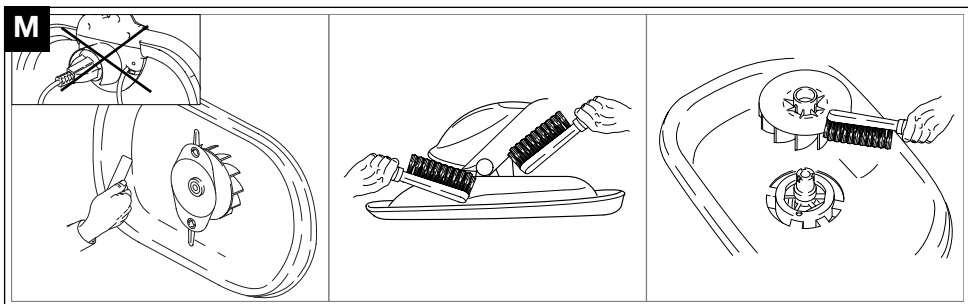
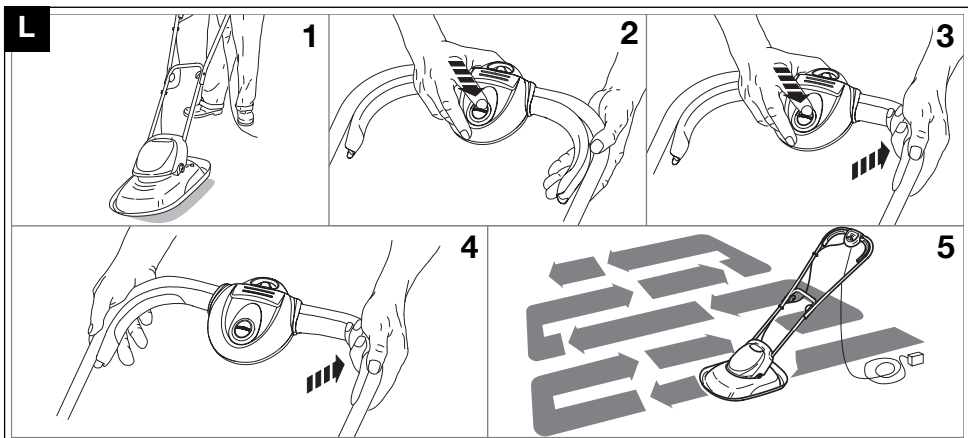

**GB** DO NOT use liquids for cleaning.  
**DE** Zur Reinigung **KEINE** Flüssigkeiten verwenden.  
**FR** **NE PAS** utiliser de produit liquide pour le nettoyage.  
**NL** Voor het reinigen **NOOIT** vloeistoffen gebruiken.  
**NO** Flytende midler **MÅ IKKE** brukes til rengjøring.

**FI** **ALA** käyttää nesteitä puhdistamiseen.  
**SE** **ANVÄND INTE** vätskor för rengöring.  
**DK** **BRUG IKKE** væske til rengøring.  
**ES** **NO** utilice líquidos para la limpieza.  
**PT** **NÃO** use líquidos para limpar.  
**IT** **NON** usare liquidi per la pulizia.  
**HU** **NE** használjon folyadékokat tisztításra.  
**PL** **NIE** używać płynów do czyszczenia.

**CZ** K čištění **NEPOUŽÍVEJTE** kapaliny.  
**SK** **NEPOUŽÍVAJTE** na čistenie tekuté materiály.  
**SI** **NE** uporabljajte raznih tekočin za čiščenje.  
**HR** **NEMOJTE** koristiti tekućine za čišćenje.  
**BA** **NEMOJTE** da koristite tečnosti za čišćenje.  
**CS** **НИКАДА** не користите течности за чишћење.

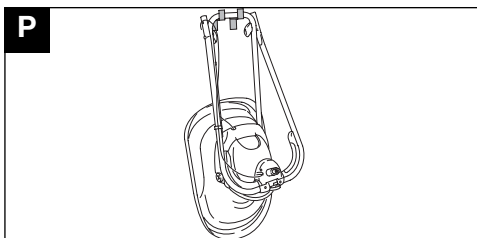
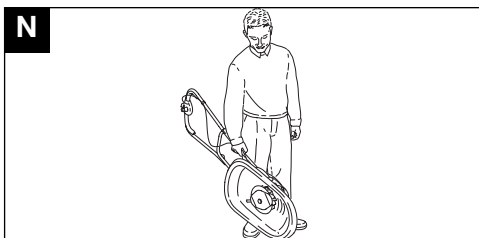

**GB** For further advice or repairs, contact your local dealer.  
**DE** Für weitere Empfehlungen oder Reparaturarbeiten setzen Sie sich bitte mit Ihrem örtlichen Händler in Verbindung.  
**FR** Pour en savoir plus ou pour toute réparation, contactez votre revendeur local.  
**NL** Voor nadere informatie over reparaties kunt u contact opnemen met uw plaatselijke leverancier.  
**NO** Ta kontakt med din lokale forhandler angående ytterligere opplysninger eller reparasjoner.  
**FI** Tarkempia ohjeita tai tieto korjauksista saat paikalliselta jälleenmyyjältä.

**SE** För ytterligare rådgivning eller reparationer, kontakta din lokala återförsäljare.  
**DK** For yderligere vejledning eller reparation skal du kontakte din lokale forhandler.  
**ES** Si desea consejos adicionales o reparación, contacte con su distribuidor local.  
**PT** Para orientação adicional ou reparações, contacte o seu agente local.  
**IT** Per ulteriori consigli o riparazioni contattate il rivenditore locale.  
**HU** További tanácsért vagy javítás szükségessége esetén forduljon a helyi forgalmazóhoz.

**PL** W sprawie porad lub napraw skontaktować się z miejscowym przedstawicielem.  
**CZ** O radu nebo opravu požádejte svého místního prodejce.  
**SK** Ďalšie informácie a opravy zabezpečí váš lokálny predajca.  
**SI** Za nadaljnja navodila ali popravila kontaktirajte vasega lokalnega prodajalca.  
**HR** Za daljnije savjete ili popravke, obratite se svom prodavaču.  
**BA** Za daljnije savjete ili popravke, obratite se svom trgovcu.  
**CS** Za dalejší saвете o popravkama, obratite se lokalnom prodavcu.

### EC DECLARATION OF CONFORMITY

<p>I, the undersigned M. Bowden of Electrolux Outdoor Products, Aycliffe Industrial Park, <b>NEWTON AYCLIFFE</b>, Co. Durham. DL5 6UP. Certify that the Product:-                  Category.....<b>Electric Lawn Trimmer</b>                  Make.....<b>Electrolux Outdoor Products</b>                  Conforms to the specifications of Directive 2000/14/EEC</p>	<p>I, the undersigned M. Bowden of Electrolux Outdoor Products, Aycliffe Industrial Park, <b>NEWTON AYCLIFFE</b>, Co. Durham. DL5 6UP. Certify that a sample of the above product has been tested using directive 81/1051/EEC as a guide. The maximum A-weighted sound pressure level recorded at operator position under free field semi anechoic chamber conditions was :-</p>	<p>I, the undersigned M. Bowden of Electrolux Outdoor Products, Aycliffe Industrial Park, <b>NEWTON AYCLIFFE</b>, Co. Durham. DL5 6UP. Certify that a sample of the above product has been tested using ISO 5349 as a guide. The maximum weighted root mean square value of vibration recorded at operator's hand position was:-</p>
Type of Cutting Device..... <b>Plastic Cutter</b> Identification of Series..... <b>See Product Rating Label</b> Conformity Assessment Procedure..... <b>ANNEX VI</b> Notified Body..... <b>I.T.S., Cleeve Road, Leatherhead, Surrey, KT22 7SB England</b> Other Directives:..... <b>98/37/EEC, 89/336/EEC, 73/23/EEC</b> & applicable standards:-..... <b>EN786, IEC60335-1, IEC60335-2-91, EN61000-3-2, EN61000-3-3, EN55014-1, EN55014-2</b>	Type..... <b>A</b> Width of Cut..... <b>B</b> Speed of Rotation of Cutting Device..... <b>C</b> Guaranteed sound power level..... <b>D</b> Measured Sound Power Level..... <b>E</b> Level..... <b>F</b> Value..... <b>G</b> Weight..... <b>H</b>	

### EC KONFORMITÄTSEKLRÄRING

<p>Ich, der Unterzeichner M. Bowden of Electrolux Outdoor Products, Aycliffe Industrial Park, <b>NEWTON AYCLIFFE</b>, Co. Durham. DL5 6UP. Bescheinigung, dass das Produkt:-                  Kategorie.....<b>Elektrosrasentrimmer</b>                  Fabrikat.....<b>Electrolux Outdoor Products</b>                  die Spezifikationen der Direktive 2000/14/EEG erfüllt</p>	<p>Ich, der Unterzeichner M. Bowden, Electrolux Outdoor Products, Aycliffe Industrial Park, <b>NEWTON AYCLIFFE</b>, Co. Durham, DL5 6UP, bescheinige hiermit, daß eine Probe des obigen Produkts getestet wurde und dabei Direktive 81/1051/EWG als Richtschnur verwendet wurde. Der maximale A-gewichtete Schalldruckpegel, der an der Bedienerposition unter Freifeld-Halbschalltkammerbedingungen gemessen wurde, betrug:-</p>	<p>Ich, der Unterzeichner M. Bowden, Electrolux Outdoor Products, Aycliffe Industrial Park, <b>NEWTON AYCLIFFE</b>, Co. Durham, DL5 6UP, bescheinige hiermit, daß eine Probe des obigen Produkts getestet wurde und dabei ISO 5349 als Richtschnur verwendet wurde. Der maximale gewichtete Vibrationseffektivwert, der an der Handposition des Bedieners gemessen wurde, betrug:-</p>
Schneidwerktyp..... <b>Kunststoffklingen</b> Identifizierung der reihe..... <b>Siehe Produkttypenschild</b> Konformitätsbestätigungsverfahren..... <b>ANNEX VI</b> Benachrichtigte Behörde..... <b>I.T.S., Cleeve Road, Leatherhead, Surrey, KT22 7SB England</b> Andere Direktiven..... <b>98/37/EEC, 89/336/EEC, 73/23/EEC</b> und Normen:-..... <b>EN786, IEC60335-1, IEC60335-2-91, EN61000-3-2, EN61000-3-3, EN55014-1, EN55014-2</b>	Typ..... <b>A</b> Schnittbreite..... <b>B</b> Umdrehungsgeschwindigkeit des Schneidwerks..... <b>C</b> Garantierter Geräuschpegel..... <b>D</b> Gemessener Geräuschpegel..... <b>E</b> Höhe..... <b>F</b> Wert..... <b>G</b> Gewicht..... <b>H</b>	

### EC DÉCLARATION DE CONFORMITÉ

<p>Je soussigné M. Bowden of Electrolux Outdoor Products, Aycliffe Industrial Park, <b>NEWTON AYCLIFFE</b>, Co. Durham. DL5 6UP. Certifie que ce produit:-                  Catégorie.....<b>Coupe-bordure électrique</b>                  Marque.....<b>Electrolux Outdoor Products</b>                  est conforme aux spécifications de la Directive 2000/14/EEC</p>	<p>Je soussigné M. Bowden, Electrolux Outdoor Products, Aycliffe Industrial Park, <b>NEWTON AYCLIFFE</b>, Co. Durham, DL5 6UP, Grande-Bretagne, certifie qu'un échantillon du produit ci-dessus a été essayé selon les indications de la directive 81/1051/EEC. Le niveau maximum pondéré de pression acoustique enregistrée à la position de l'opérateur en champ libre en chambre demi-sourde était de:-</p>	<p>Je soussigné M. Bowden, Electrolux Outdoor Products, Aycliffe Industrial Park, <b>NEWTON AYCLIFFE</b>, Co. Durham, DL5 6UP, Grande-Bretagne, certifie qu'un échantillon du produit ci-dessus a été essayé selon les indications de la norme ISO 5349. La moyenne quadratique pondérée des vibrations enregistrées à la position de la main de l'opérateur était de:-</p>
Type d'outil de coupe..... <b>Racler en plastique</b> Identification de la serie..... <b>Voir la Plaqueette D'identification</b> Procédure d'évaluation de la conformité..... <b>ANNEX VI</b> Organisme notifié..... <b>I.T.S., Cleeve Road, Leatherhead, Surrey, KT22 7SB England</b> Autres directives..... <b>98/37/EEC, 89/336/EEC, 73/23/EEC</b> et aux normes..... <b>EN786, IEC60335-1, IEC60335-2-91, EN61000-3-2, EN61000-3-3, EN55014-1, EN55014-2</b>	Type..... <b>A</b> Largeur de coupe..... <b>B</b> Vitesse de rotation de l'outil de coupe..... <b>C</b> Niveau garanti de puissance sonore..... <b>D</b> Niveau mesuré de puissance sonore..... <b>E</b> Niveau..... <b>F</b> Valeur..... <b>G</b> Poids..... <b>H</b>	

### EC KONFORMITEITSVERKLARING

<p>Ik, ondergetekende M. Bowden of Electrolux Outdoor Products, Aycliffe Industrial Park, <b>NEWTON AYCLIFFE</b>, Co. Durham. DL5 6UP. Verklaaren dat het product:-                  Categorie.....<b>Elektrisk grazonmaaier</b>                  Merk.....<b>Electrolux Outdoor Products</b>                  Voldoet aan de specificaties van directief 2000/14/EEC</p>	<p>Ik, ondergetekende M. Bowden, Electrolux Outdoor Products, Aycliffe Industrial Park, <b>NEWTON AYCLIFFE</b>, Co. Durham, DL5 6UP, verklaar hierbij dat een proefexemplaar van het bovengenoemde product is getest volgens richtlijn 81/1051/EEC. Het maximale A-belaste geluidsdrukniveau dat is geregistreerd bij de positie van de bediener in een semi geluiddichte ruimte bij vrije veld condities bedraagt:-</p>	<p>Ik, ondergetekende M. Bowden, Electrolux Outdoor Products, Aycliffe Industrial Park, <b>NEWTON AYCLIFFE</b>, Co. Durham, DL5 6UP, verklaar hierbij dat een proefexemplaar van het bovengenoemde product is getest volgens ISO 5349 als richtlijn. De maximale belaste effectieve waarde van trilling, geregistreerd bij de positie van de hand van de bediener, bedraagt:-</p>
Type maaier..... <b>Plastic messen</b> Identificatie van serie..... <b>Zie Productlabel</b> Procedure voor het beoordelen van conformiteit..... <b>ANNEX VI</b> Op de hoogte gestelde instantie..... <b>I.T.S., Cleeve Road, Leatherhead, Surrey, KT22 7SB England</b> Andere directieven..... <b>98/37/EEC, 89/336/EEC, 73/23/EEC</b> en aan de volgende normen..... <b>EN786, IEC60335-1, IEC60335-2-91, EN61000-3-2, EN61000-3-3, EN55014-1, EN55014-2</b>	Type..... <b>A</b> Maaibreedte..... <b>B</b> Toerental maaier..... <b>C</b> Gegarandeerd geluidsvermogen..... <b>D</b> Gemeten geluidsvermogen..... <b>E</b> Niveau..... <b>F</b> Waarde..... <b>G</b> Gewicht..... <b>H</b>	

### EC KONFORMITETSEKLRÆRING

<p>Undertegnede, M. Bowden of Electrolux Outdoor Products, Aycliffe Industrial Park, <b>NEWTON AYCLIFFE</b>, Co. Durham. DL5 6UP. Attesterer at produktet:-                  Kategori.....<b>Elektrisk plenklipper</b>                  Merke.....<b>Electrolux Outdoor Products</b>                  Svarer til spesifikasjonene i Direktiv 2000/14/EEC</p>	<p>Undertegnede, M. Bowden, Electrolux Outdoor Products, Aycliffe Industrial Park, <b>NEWTON AYCLIFFE</b>, Co. Durham, DL5 6UP bevtinner at en prøve av ovennevnte produkt er testet, med direktiv 81/1051/EEC som retledning. Maksimum A-belastede lydtrykknivå, registrert ved brukerens plassering, under fritt felt halvveis ekokfritt kammerforhold, var :-</p>	<p>Undertegnede, M. Bowden, Electrolux Outdoor Products, Aycliffe Industrial Park, <b>NEWTON AYCLIFFE</b>, Co. Durham, DL5 6UP bevtinner at en prøve av ovennevnte produkt er testet, med direktiv ISO 5349 som retledning. Maksimum belastede effektivverdi av vibrering, registrert ved plasseringen av brukerens hånd, var:-</p>
Type klippemreining..... <b>Plastkliner avstandsstykker</b> Serieidentifikasjon..... <b>Se Produktets Klassifiseringsetikett</b> Prosedyre for konformitetsvurdering..... <b>ANNEX VI</b> Etat det er meldt fra til..... <b>I.T.S., Cleeve Road, Leatherhead, Surrey, KT22 7SB England</b> Andre direktiver..... <b>98/37/EEC, 89/336/EEC, 73/23/EEC</b> og standarder..... <b>EN786, IEC60335-1, IEC60335-2-91, EN61000-3-2, EN61000-3-3, EN55014-1, EN55014-2</b>	Type..... <b>A</b> Klippebredde..... <b>B</b> Klippemreiningens rotasjons hastighet..... <b>C</b> Garantert lydkraftnivå..... <b>D</b> Målt lydkraftnivå..... <b>E</b> Nivå..... <b>F</b> Verdi..... <b>G</b> Vekt..... <b>H</b>	

## EC VAATIMUSTENMUSTENMUKAISUUSVAKUUTUS

Minä allekirjoittanut M. Bowden of Electrolux Outdoor Products, Aycliffe Industrial Park, <b>NEWTON AYCLIFFE</b> , Co. Durham. DL5 6UP. Varmistaa, että laite:- Luokitus..... <b>Sähkökäyttöinen nurmikonsiistijä</b> Merkki..... <b>Electrolux Outdoor Products</b> Vastaa direktiivin 2000/14/ETY vaatimuksia.	Minä allekirjoittanut M. Bowden, Electrolux Outdoor Products, Aycliffe Industrial Park, <b>NEWTON AYCLIFFE</b> , Co. Durham DL5 6UP, vahvistan, että yllä mainitun tuotteen näytekalpalle on tarkastettu käytäen EU-direktiiviä 81/1051/ETY viitteenä. Suurin A-painotettu käyttäjän kohdalla mitattu äänenpainetaso puoliakustattomassa huoneessa käyttäjän tasolla oli seuraava:-	Minä allekirjoittanut M. Bowden, Electrolux Outdoor Products, Aycliffe Industrial Park, <b>NEWTON AYCLIFFE</b> , Co. Durham DL5 6UP, vahvistan, että yllä mainitun tuotteen näytekalpalle on tarkastettu käyttäen ISO 5349 -standardia viitteenä. Suurin painotettu käsiavaraistarinä käyttäjän käden kohdalla oli seuraava:-
Leikkauslaitteen tyyppi..... <b>Muovi terät</b> Sarjan Tunnus..... <b>Katso Tuotteen Arvokilpää</b> Yhdenmukaisuusarviointi..... <b>ANNEX VI</b> Tiedotusosaajilla..... <b>I.T.S., Cleeve Road, Leatherhead, Surrey, KT22 7SB England</b> Muut direktiivit..... <b>98/37/EEC, 89/336/EEC, 73/23/EEC</b> e osat standardit..... <b>EN786, IEC60335-1, IEC60335-2-91, EN61000-3-2, EN61000-3-3, EN55014-1, EN55014-2</b>	Tyyppi..... <b>A</b> Leikkausleveys..... <b>B</b> Leikkauslaitteen pyörimisnopeus..... <b>C</b> Taattu luotettava tehontaso..... <b>D</b> Mitattu luotettava tehontaso..... <b>E</b> Taso ..... <b>F</b> Arvo..... <b>G</b> Paino..... <b>H</b>	

## EC FÖRSÄKRAN OM ÖVERENSSTÄMMELE

Jag, undertecknad M. Bowden of Electrolux Outdoor Products, Aycliffe Industrial Park, <b>NEWTON AYCLIFFE</b> , Co. Durham. DL5 6UP. Intyga att produkten:- Kategori..... <b>Elektrisk kantklippare</b> Tillverkare..... <b>Electrolux Outdoor Products</b> överensstämmer med specifikationerna i direktiv 2000/14/EEC	Jag, undertecknad M. Bowden, Electrolux Outdoor Products, Aycliffe Industrial Park, <b>NEWTON AYCLIFFE</b> , Co Durham, DL5 6UP, betygar att ett exemplar av ovan nämnda produkt har testats med bestämmelse 81/1051/EEC som riktlinje. Det maximala A-vägda ljudtrycknivån som uppmättes vid körplatsen under förhållanden i en frifälts halvt ekofri kammare var:-	Jag, undertecknad M. Bowden, Electrolux Outdoor Products, Aycliffe Industrial Park, <b>NEWTON AYCLIFFE</b> , Co Durham, DL5 6UP, betygar att ett exemplar av ovan nämnda produkt har testats med bestämmelse ISO 5349 som riktlinje. Det maximala vägda kvadratiska medelvärdet för vibration som uppmätts vid förarens handläge var:-
Typ av klippanordning..... <b>Skärblad av plast</b> Identifiering av serie..... <b>Se Produktidentifieringsetikett</b> Metod för bedömning av överensstämmelse..... <b>ANNEX VI</b> Notifierat organ..... <b>I.T.S., Cleeve Road, Leatherhead, Surrey, KT22 7SB England</b> Andra direktiv..... <b>98/37/EEC, 89/336/EEC, 73/23/EEC</b> samt tillhörande standarder..... <b>EN786, IEC60335-1, IEC60335-2-91, EN61000-3-2, EN61000-3-3, EN55014-1, EN55014-2</b>	Typ..... <b>A</b> Klippbredd..... <b>B</b> Varvtal på klippanordning..... <b>C</b> Garanterat ljudnivå på motor..... <b>D</b> Uppmätt ljudnivå på motor..... <b>E</b> Nivå..... <b>F</b> Värde..... <b>G</b> Vikt..... <b>H</b>	

## EC ÖVERENSSTÄMMELESERKLÄRING

Undertegnede, M. Bowden of Electrolux Outdoor Products, Aycliffe Industrial Park, <b>NEWTON AYCLIFFE</b> , Co. Durham. DL5 6UP. Kontrollerer, at produkt:- Kategori..... <b>Elektrisk græsstrimmer</b> Fabrikat..... <b>Electrolux Outdoor Products</b> over holder specifikationerne i direktivet 2000/14/EOF	Undertegnede, M. Bowden, Electrolux Outdoor Products, Aycliffe Industrial Park, <b>NEWTON AYCLIFFE</b> , Co. Durham DL5 6UP, attesterer herved, at en prøve af ovenstående produkt er blevet testet, idet direktiv 81/1051/EEC er blevet anvendt som vejledning. Det maksimale A-vægtede lydtrykniveau, som er blevet målt på brugerpositionen i et frifelts halvdødt rum var:-	Undertegnede, M. Bowden, Electrolux Outdoor Products, Aycliffe Industrial Park, <b>NEWTON AYCLIFFE</b> , Co. Durham DL5 6UP, attesterer herved, at en prøve af ovenstående produkt er blevet testet, idet ISO 5349 er blevet benyttet som vejledning. Den maksimale vægtede effektværdi for vibration som er blevet registreret ved brugerens håndposition var:-
Type klippehed..... <b>Plastskærebåde</b> Identifikation af serie..... <b>Se Produktmærkat</b> Fremgængemåde til vurdering af overensstemmelse..... <b>ANNEX VI</b> Underrettet organ..... <b>I.T.S., Cleeve Road, Leatherhead, Surrey, KT22 7SB England</b> Andre direktiver..... <b>98/37/EEC, 89/336/EEC, 73/23/EEC</b> og standarderne..... <b>EN786, IEC60335-1, IEC60335-2-91, EN61000-3-2, EN61000-3-3, EN55014-1, EN55014-2</b>	Type..... <b>A</b> Klippebredde..... <b>B</b> Klippemødens rotationshastighed..... <b>C</b> Garanteret lydeffektniveau..... <b>D</b> Målt lydeffektniveau..... <b>E</b> Niveau..... <b>F</b> Værdi..... <b>G</b> Vægt ..... <b>H</b>	

## EC DECLARACIÓN DE CONFORMIDAD

El abajo firmante M. Bowden of Electrolux Outdoor Products, Aycliffe Industrial Park, <b>NEWTON AYCLIFFE</b> , Co. Durham. DL5 6UP. Certifico que el producto:- Categoría..... <b>Cortadora de césped eléctrica</b> Marca..... <b>Electrolux Outdoor Products</b> Está conforme con las especificaciones de la Directiva 2000/14/EEC	El abajo firmante M. Bowden, Electrolux Outdoor Products, Aycliffe Industrial Park, <b>NEWTON AYCLIFFE</b> , Co. Durham DL5 6UP. Certifico que ha sido probada una muestra del producto anteriormente mencionado utilizando la directiva 81/1051/EEC como guía. El máximo nivel de presión de sonido ponderado A registrado en la posición del operario bajo condiciones de cámara anecoica de semi campo fue de:-	El abajo firmante M. Bowden, Electrolux Outdoor Products, Aycliffe Industrial Park, <b>NEWTON AYCLIFFE</b> , Co. Durham DL5 6UP. Certifico que ha sido probada una muestra del producto anteriormente mencionado utilizando como guía ISO 5349. El valor máximo ponderado de la media de la raíz cuadrada de la vibración registrada en la posición de la mano del operario fue de:-
Tipo de dispositivo de corte..... <b>Cortadoras plásticas</b> Identificación de la serie..... <b>Ver Etiqueta de Identificación Del Producto</b> Procedimiento de evaluación de conformidad..... <b>ANNEX VI</b> Organismo notificado..... <b>I.T.S., Cleeve Road, Leatherhead, Surrey, KT22 7SB England</b> Otras directivas..... <b>98/37/EEC, 89/336/EEC, 73/23/EEC</b> y con las normativas..... <b>EN786, IEC60335-1, IEC60335-2-91, EN61000-3-2, EN61000-3-3, EN55014-1, EN55014-2</b>	Tipo..... <b>A</b> Anchura de corte..... <b>B</b> Velocidad de rotación del dispositivo de corte..... <b>C</b> Nivel de potencia sonora garantizado..... <b>D</b> Nivel de potencia sonora medido..... <b>E</b> Nivel..... <b>F</b> Valor..... <b>G</b> Peso..... <b>H</b>	

## EC DECLARAÇÃO DE CONFORMIDADE

Eu, abaixo assinado, M. Bowden of Electrolux Outdoor Products, Aycliffe Industrial Park, <b>NEWTON AYCLIFFE</b> , Co. Durham. DL5 6UP. Certifico que o produto:- Categoria..... <b>Máquina de Cortar Relva (Trimmer) Eléctrica</b> Marca..... <b>Electrolux Outdoor Products</b> Está em conformidade com a Directiva 2000/14/CEE	Eu, abaixo assinado, M. Bowden, Electrolux Outdoor Products, Aycliffe Industrial Park, <b>NEWTON AYCLIFFE</b> , Co. Durham, DL5 6UP. Certifico que uma amostra do produto acima foi testada tendo como guia a directiva 81/1051/CEE. O valor máximo da média pesada A do nível de pressão do som registado na posição do operador, em condições de câmara semi-anecoica de campo livre foi:-	Eu, abaixo assinado, M. Bowden, Electrolux Outdoor Products, Aycliffe Industrial Park, <b>NEWTON AYCLIFFE</b> , Co. Durham, DL5 6UP. Certifico que uma amostra do produto acima foi testada tendo como guia a norma ISO 5349. O valor máximo da média quadrática pesada da vibração registado na posição da mão do operador foi:-
Tipo de Dispositivo de Corte..... <b>Cortadores de plástico</b> Identificação da série..... <b>Consulte a Etiqueta de Especificações do Produto</b> Procedimento de Avaliação de Conformidade..... <b>ANNEX VI</b> Órgão Notificado..... <b>I.T.S., Cleeve Road, Leatherhead, Surrey, KT22 7SB England</b> Outras Directivas..... <b>98/37/EEC, 89/336/EEC, 73/23/EEC</b> e com as normas..... <b>EN786, IEC60335-1, IEC60335-2-91, EN61000-3-2, EN61000-3-3, EN55014-1, EN55014-2</b>	Tipo ..... <b>A</b> Largura de Corte..... <b>B</b> Velocidade de Rotação do Dispositivo de Corte..... <b>C</b> Nivel de Intensidade de Som Garantido..... <b>D</b> Nivel de Intensidade de Som Medido..... <b>E</b> Nivel..... <b>F</b> Valor..... <b>G</b> Peso..... <b>H</b>	

### EC DICHIARAZIONE DI CONFORMITÀ

Il sottoscritto M. Bowden di Electrolux Outdoor Products, Aycliffe Industrial Park, <b>NEWTON AYCLIFFE</b> , Co. Durham, DL5 6UP. Certificare che il prodotto:- Categoria:..... <b>Tagliabordi elettrico</b> Marca:..... <b>Electrolux Outdoor Products</b> è conforme alle normative della Direttiva 2000/14/CEE	Il sottoscritto, M. Bowden, Electrolux Outdoor Products, Aycliffe Industrial Park, <b>NEWTON AYCLIFFE</b> , Co. Durham, DL5 6UP, dichiara che un campione del suddetto prodotto è stato testato in base alla direttiva 81/1051/CEE. Il livello massimo di pressione sonora categoria A rilevato in corrispondenza della posizione di guida in condizioni di camera semianecoica in campo libero era di:-	Il sottoscritto, M. Bowden, Electrolux Outdoor Products, Aycliffe Industrial Park, <b>NEWTON AYCLIFFE</b> , Co. Durham, DL5 6UP, dichiara che un campione del suddetto prodotto è stato testato in base alla direttiva ISO 5349. Il valore ponderale massimo di vibrazione sonora efficace rilevato in corrispondenza delle mani dell'operatore era di:-
Tipo di lama..... <b>Lame di plastica</b> Identificazione serie..... <b>Vedi Etichetta Dati Prodotto</b> Procedura di valutazione della conformità..... <b>ANNEX VI</b> Ente notificato..... <b>I.T.S., Cleeve Road, Leatherhead, Surrey, KT22 7SB England</b> Altre direttive..... <b>98/37/EEC, 89/336/EEC, 73/23/EEC</b> e alle normative..... <b>EN786, IEC60335-1, IEC60335-2-91, EN61000-3-2, EN61000-3-3, EN55014-1, EN55014-2</b>		Tipo..... <b>A</b> Larghezza di taglio..... <b>B</b> Velocità di rotazione della lama..... <b>C</b> Livello sonoro misurato..... <b>D</b> Livello sonoro misurato..... <b>E</b> Livello..... <b>F</b> Valore..... <b>G</b> Peso..... <b>H</b>

### EC MEGFELELŐSÉGI TANÚSÍTVÁNY

Alulírott, M. Bowden of Electrolux Outdoor Products, Aycliffe Industrial Park, <b>NEWTON AYCLIFFE</b> , Co. Durham, DL5 6UP. Alulírott, tanúsítom, hogy a termék:- Kategória:..... <b>Elektromos trimmelő</b> Gyártmány..... <b>Electrolux Outdoor Products</b> megfelel a 2000/14/EEC direktívák specifikációinak	Alulírott, M. Bowden, Electrolux Outdoor Products, Aycliffe Industrial Park, <b>NEWTON AYCLIFFE</b> , Co. Durham, DL5 6UP. Igazolom, hogy a fenti termékintá a 81/1051/EEC szabályok szerinti tesztelték. A szabad hangtéri, félig visszahangmentes kamrai körülmények közötti, kezelti helyzetben rögzített maximálisan atmoszferikusan-nehezített hangnyomásszint:	Alulírott, M. Bowden, Electrolux Outdoor Products, Aycliffe Industrial Park, <b>NEWTON AYCLIFFE</b> , Co. Durham, DL5 6UP. Igazolom, hogy a fenti termékintá az ISO 5349 szabályzat szerint tesztelték. A kezelő kézhelyzetében rögzített vibráció maximálisan súlyozott effektív bemeneti zajhőmértékelet:-
Vágóéltípus..... <b>Műanyag vágóécs</b> Szeria azonosítása..... <b>Lásd a Termékminősítő Cédulát</b> Termékmegfelelőség..... <b>ANNEX VI</b> Értésített testület..... <b>I.T.S., Cleeve Road, Leatherhead, Surrey, KT22 7SB England</b> Egyéb direktívák..... <b>98/37/EEC, 89/336/EEC, 73/23/EEC</b> valamint az..... <b>EN786, IEC60335-1, IEC60335-2-91, EN61000-3-2, EN61000-3-3, EN55014-1, EN55014-2</b>		Típus..... <b>A</b> Vágószélesség..... <b>B</b> Vágóélt forgássebessége..... <b>C</b> Garantált hangerőszint..... <b>D</b> Mért hangerőszint..... <b>E</b> Szint..... <b>F</b> Érték..... <b>G</b> Súly..... <b>H</b>

### EC DEKLARACJA ZGODNOŚCI

Ja, niżej podpisany M. Bowden of Electrolux Outdoor Products, Aycliffe Industrial Park, <b>NEWTON AYCLIFFE</b> , Co. Durham, DL5 6UP. Zaświadczam się że produkt:- Kategoria:..... <b>Elektryczna kosiarzka do trawników</b> Wykonanie..... <b>Electrolux Outdoor Products</b> Odpowiada wymaganiom technicznym Dyrektywy Europejskiej Wspólnoty Gospodarczej (EWG) nr 2000/14/EEC	Ja, niżej podpisany M. Bowden, Electrolux Outdoor Products, Aycliffe Industrial Park, <b>NEWTON AYCLIFFE</b> , Co. Durham DL5 6UP Anglia, oświadczam, że próbka powyższego wyrobu została przebadana stosując dyrektywę 81/1051/EEC jako wzór. Maksymalny poziom ciśnienia akustycznego, ważonego średnio A, przy pozycji operatora w warunkach częściowo bezchłowej komory akustycznej pochłaniającej był:-	Ja, niżej podpisany M. Bowden, Electrolux Outdoor Products, Aycliffe Industrial Park, <b>NEWTON AYCLIFFE</b> , Co. Durham DL5 6UP Anglia, oświadczam, że próbka powyższego wyrobu została przebadana stosując ISO 5349 jako wzór. Maksymalna ważona wartość średnia kwadratuwa vibracji zapisana w pozycji ręki operatora była:-
Typ Urządzenia Tnącego..... <b>Plastykowe noże</b> Identyfikacja serii..... <b>Patrz Tabliczka Znamionowa Wyrobu</b> Procedura Oceny Zgodności..... <b>ANNEX VI</b> Organ Rejestrujący..... <b>I.T.S., Cleeve Road, Leatherhead, Surrey, KT22 7SB England</b> Inne Dyrektywy..... <b>98/37/EEC, 89/336/EEC, 73/23/EEC</b> oraz norm..... <b>EN786, IEC60335-1, IEC60335-2-91, EN61000-3-2, EN61000-3-3, EN55014-1, EN55014-2</b>		Typ..... <b>A</b> Szerokość koszenia..... <b>B</b> Prędkość Obrótowa Urządzenia Tnącego..... <b>C</b> Gwarantowany Poziom Mocy Akustycznej..... <b>D</b> Mierzony Poziom Mocy Akustycznej..... <b>E</b> Poziom..... <b>F</b> Wartość..... <b>G</b> Odważnik..... <b>H</b>

### ES PROHLÁSENÍ O SHODĚ

Já, níže podepsaný M. Bowden, Electrolux Outdoor Products, Aycliffe Industrial Park, <b>NEWTON AYCLIFFE</b> , Co. Durham, DL5 6UP. Potvrzují, že tento výrobek:- Kategorie..... <b>Elektrická sekačka na trávu</b> Značka..... <b>Electrolux Outdoor Products</b> Vyhovuje specifikacím Směrnice 2000/14/EEC	Já, níže podepsaný M. Bowden, Electrolux Outdoor Products, Aycliffe Industrial Park, <b>NEWTON AYCLIFFE</b> , Co. Durham, DL5 6UP, prohlašuji, že vzorek shora uvedeného výrobku byl odtoučen v souladu se Směrnicí 81/1051/EEC. Maximální A-vážená úroveň tlaku zvuku zaznamenaná v místě obsluhy v podmínkách volného pole zvukově izolované komory, byla:-	Já, níže podepsaný M. Bowden, Electrolux Outdoor Products, Aycliffe Industrial Park, <b>NEWTON AYCLIFFE</b> , Co. Durham, DL5 6UP, prohlašuji, že shora uvedený výrobek byl odtoučen v souladu s normou ISO 5349. Maximální vážený průměr hodnoty vibrací, které byly zaznamenány u směru umístění ruky obsluhy, byla:-
Typ začho nástroje..... <b>Plastové začho nože</b> Identifikace série..... <b>Viz Výrobní štítek</b> Postup při posuzování shody..... <b>ANNEX VI</b> Autorizovaná osoba..... <b>I.T.S., Cleeve Road, Leatherhead, Surrey, KT22 7SB England</b> Použité Směrnice..... <b>98/37/EEC, 89/336/EEC, 73/23/EEC</b> a normy..... <b>EN786, IEC60335-1, IEC60335-2-91, EN61000-3-2, EN61000-3-3, EN55014-1, EN55014-2</b>		Typ..... <b>A</b> Šírka sekání..... <b>B</b> Počet otáček začho nástroje..... <b>C</b> Garantovaná hladina akustického výkonu..... <b>D</b> Naměřená hladina akustického výkonu..... <b>E</b> Úroveň..... <b>F</b> Hmotnost..... <b>G</b> Hmotnost..... <b>H</b>

### EC PREHLÁSENIE O PRAVNEJ SPOSOBILOSTI TOVARU

Ja, dolupodpisany, M. Bowden of Electrolux Outdoor Products, Aycliffe Industrial Park, <b>NEWTON AYCLIFFE</b> , Co. Durham, DL5 6UP. Potvrdzujeme, že výrobok :- Kategória..... <b>Elektrická kosačka trávy</b> Výroba..... <b>Electrolux Outdoor Products</b> Vyhovuje špecifikáciám uvedeným v Norme 2000/14/EEC	Ja, dopodpisany, M. Bowden, Electrolux Outdoor Products, Aycliffe Industrial Park, v meste <b>NEWTON AYCLIFFE</b> , Co. Durham, DL5 6UP, týmto potvrdzujem, že vzorka hore menovaného výrobku bola otestovaná v súlade s predpisom 81/1051/EEC. Pri maximálnom zaťažení úroveň tlaku zvuku nameraná u operátora za podmienok voľného polového pôsobenia polo-anechoického priestoru bola:-	Ja, dopodpisany, M. Bowden, Electrolux Outdoor Products Park, Aycliffe Industrial Park, v meste <b>NEWTON AYCLIFFE</b> , Co. Durham, DL5 6UP, týmto potvrdzujem, že vzorka hore menovaného výrobku bola otestovaná v súlade s predpisom ISO 5349. Pri maximálnom zaťažení základný priemer druhej mocniny vibrácie nameraný u operátora ruky bol:-
Typ rezného telesa..... <b>Plastové nože</b> Identifikácia série..... <b>Vid Štítok Parametrov Výrobku</b> Postup určenia právnej spôsobilosti tovaru..... <b>ANNEX VI</b> Informované orgány..... <b>I.T.S., Cleeve Road, Leatherhead, Surrey, KT22 7SB England</b> Ďalšie nariadenia..... <b>98/37/EEC, 89/336/EEC, 73/23/EEC</b> a normám..... <b>EN786, IEC60335-1, IEC60335-2-91, EN61000-3-2, EN61000-3-3, EN55014-1, EN55014-2</b>		Typ..... <b>A</b> Šírka skosu..... <b>B</b> Rýchlosť rotácií rezného telesa..... <b>C</b> Garantovaný stupeň sily zvuku..... <b>D</b> Nameryany stupeň sily zvuku..... <b>E</b> Úroveň..... <b>F</b> Hodnota..... <b>G</b> Váha..... <b>H</b>

## EC IZJAVA PROIZVAJALCA O SKLADNOSTI PROIZVODA Z STANDARDI

Spodaj podpisani M. Bowden of Electrolux Outdoor Products, Aycliffe Industrial Park, <b>NEWTON AYCLIFFE</b> , Co. Durham. DL5 6UP. Potrjujemo, da je proizvod:- Kategorija..... <b>električni obrezovalnik za robove travnih površin</b> blagovna znanaka..... <b>Electrolux Outdoor Products</b> v skladu z določbami Direktive 2000/14/EEC	Spodaj podpisani M. Bowden, Electrolux Outdoor Products, Aycliffe Industrial Park, <b>NEWTON AYCLIFFE</b> , Co. Durham DL5 6UP potrjujem, da je bil primerek zgornjega proizvoda testiran glede na pravilnik 81/1051/EEC. Maksimalni nivo pritiska zvoka A-jakosti, ki je bil zabeležen na poziciji upravnika v pogojih prostega polja semi-anoakoične komore je bil:-	Spodaj podpisani M. Bowden, Electrolux Outdoor Products, Aycliffe Industrial Park, <b>NEWTON AYCLIFFE</b> , Co. Durham. DL5 6UP potrjujem, da je bil primerek zgornjega proizvoda testiran glede na pravilnik ISO 5349. Maksimalna povprečna zmerjena vrednost korena na kvadrat za vibriranje, zabeležena na poziciji upravnikev je bila roke je bila:-
Vrsta naprave za rezanje..... <b>Plastična rezila</b> Identifikacija serije..... <b>Glej Etiketo Označbe Proizvoda</b> Postopek ugotavljanja skladnosti..... <b>ANNEX VI</b> Obveščeno telo..... <b>I.T.S., Cleeve Road, Leatherhead, Surrey, KT22 7SB England</b> Druge direktive..... <b>98/37/EEC, 89/336/EEC, 73/23/EEC</b> in po standardih..... <b>EN786, IEC60335-1, IEC60335-2-91, EN61000-3-2, EN61000-3-3, EN55014-1, EN55014-2</b>	Tip..... <b>A</b> Širina reza..... <b>B</b> Hitrost rotacije naprave za rezanje..... <b>C</b> Zajamčen nivo hrupa..... <b>D</b> Izmerjen nivo hrupa..... <b>E</b> Nivo..... <b>F</b> Vrednost..... <b>G</b> Obtežitvi..... <b>H</b>	

## IZJAVA O SUKLADNOSTI - Evropska Zajednica (EC)

Ja, niže potpisani M. Bowden iz Electrolux Outdoor Products, Aycliffe Industrial Park, <b>NEWTON AYCLIFFE</b> , Co. Durham. DL5 6UP. potrjujem da je proizvod: Kategorija..... <b>Električni obrezač za travu</b> Proizvod..... <b>Electrolux Outdoor Products</b> v skladnosti sa specifikacijama Direktive 2000/14/EEC	Ja, niže potpisani M. Bowden iz Electrolux Outdoor Products, Aycliffe Industrial Park, <b>NEWTON AYCLIFFE</b> , Co. Durham. DL5 6UP. potrjujem da je primjerak gore navedenog proizvoda bi testiran prema smjernicama direktive 81/1051/EEC. Maksimalni A-ponderirani pritisak zvuka zabilježen na mjestu operatera pod uvjetima slobodnog (akustičkog) polja u polugluhoj komori bila je:	Ja, niže potpisani M. Bowden iz Electrolux Outdoor Products, Aycliffe Industrial Park, <b>NEWTON AYCLIFFE</b> , Co. Durham. DL5 6UP. potrjujem da je primjerak gore navedenog proizvoda bi testiran prema smjernicama ISO 5349. Maksimalna ponderirana srednja kvadratna vrijednost vibracije zabilježena na mjestu ruke operatera bila je:
Vrsta uređaja za rezanje..... <b>Plastični rezač</b> Identifikacija serija..... <b>Vidi etiketu s ocjenom proizvoda</b> Postupak za ocjenu skladnosti..... <b>ANNEX VI</b> Obavještena ustanova..... <b>I.T.S., Cleeve Road, Leatherhead, Surrey, KT22 7SB England</b> Druge direktive..... <b>98/37/EEC, 89/336/EEC, 73/23/EEC</b> i primjenivi standardi..... <b>EN786, IEC60335-1, IEC60335-2-91, EN61000-3-2, EN61000-3-3, EN55014-1, EN55014-2</b>	Vrsta..... <b>A</b> Širina reza..... <b>B</b> Brzina rotacije uređaja za rezanje..... <b>C</b> Garantirana razina snage zvuka..... <b>D</b> Izmjerena razina snage zvuka..... <b>E</b> Razina..... <b>F</b> Vrijednost..... <b>G</b> Težina..... <b>H</b>	

## IZJAVA O SUKLADNOSTI - Evropska Zajednica (EC)

Ja, niže potpisani M. Bowden iz Electrolux Outdoor Products, Aycliffe Industrial Park, <b>NEWTON AYCLIFFE</b> , Co. Durham. DL5 6UP. potrjujem da je proizvod: Kategorija..... <b>Električni obrezač za travu</b> Proizvod..... <b>Electrolux Outdoor Products</b> v skladnosti sa specifikacijama Direktive 2000/14/EEC	Ja, niže potpisani M. Bowden iz Electrolux Outdoor Products, Aycliffe Industrial Park, <b>NEWTON AYCLIFFE</b> , Co. Durham. DL5 6UP. potrjujem da je primjerak gore navedenog produkta bi testiran prema smjernicama direktive 81/1051/EEC. Maksimalni A-ponderirani pritisak zvuka zabilježen na lokaciji operatera pod uvjetima slobodnog (akustičkog) polja u polugluhoj komori bila je:	Ja, niže potpisani M. Bowden iz Electrolux Outdoor Products, Aycliffe Industrial Park, <b>NEWTON AYCLIFFE</b> , Co. Durham. DL5 6UP. potrjujem da je primjerak gore navedenog produkta bi testiran prema smjernicama ISO 5349. Maksimalna ponderirana srednja kvadratna vrijednost vibracije zabilježena na poziciji ruke operatera bila je:
Vrsta uređaja za rezanje..... <b>Plastični rezač</b> Identifikacija serija..... <b>Vidi etiketu s ocjenom produkta</b> Postupak za ocjenu skladnosti..... <b>ANNEX VI</b> Obavještena ustanova..... <b>I.T.S., Cleeve Road, Leatherhead, Surrey, KT22 7SB England</b> Druge direktive..... <b>98/37/EEC, 89/336/EEC, 73/23/EEC</b> i primjenivi standardi..... <b>EN786, IEC60335-1, IEC60335-2-91, EN61000-3-2, EN61000-3-3, EN55014-1, EN55014-2</b>	Vrsta..... <b>A</b> Širina reza..... <b>B</b> Brzina rotacije uređaja za rezanje..... <b>C</b> Garantirani nivo snage zvuka..... <b>D</b> Izmjereni nivo snage zvuka..... <b>E</b> Nivo..... <b>F</b> Vrijednost..... <b>G</b> Težina..... <b>H</b>	

## EУ ДЕКЛАРАЦИЈА О УСКЛАЂЕНОСТИ

Ja, done potpisani M. Bowden, iz firme Electrolux Outdoor Products, Aycliffe Industrial Park, <b>NEWTON AYCLIFFE</b> , Co. Durham. DL5 6UP. Garantujem da je proizvod:- Kategorija..... <b>Električni trimmer za travnjake</b> Marka..... <b>Electrolux Outdoor Products</b> u skladu sa specifikacijama Direktive 2000/14/EEC	Ja, done potpisani M. Bowden, iz firme Electrolux Outdoor Products, Aycliffe Industrial Park, <b>NEWTON AYCLIFFE</b> , Co. Durham. DL5 6UP. Garantujem da je uzorak gore navedenog proizvoda ispitivan u saglasnosti sa direktivom 81/1051/EEC. Maksimalni A-ponderirani nivo zvučnog pritiska zabeležen na poziciji rukovođa pod uslovima slobodnog polja u polugluvoj komori bio je:-	Ja, done potpisani M. Bowden, iz firme Electrolux Outdoor Products, Aycliffe Industrial Park, <b>NEWTON AYCLIFFE</b> , Co. Durham. DL5 6UP. Garantujem da je uzorak gore navedenog proizvoda ispitivan u saglasnosti sa standardom ISO 5349. Maksimalna ponderirana srednja kvadratna vrednost vibracija zabeleženih na poziciji ruku rukovođa bila je:-
Vrsta sečiva..... <b>Plastično sečivo</b> Oznaka serije..... <b>Vidi nalepnicu na proizvodu</b> Procedura za ispitivanje usaglašenosti..... <b>ANNEX VI</b> Obavesheno telo..... <b>I.T.S., Cleeve Road, Leatherhead, Surrey, KT22 7SB England</b> Druge direktive..... <b>98/37/EEC, 89/336/EEC, 73/23/EEC</b> i primenivi standardi..... <b>EN786, IEC60335-1, IEC60335-2-91, EN61000-3-2, EN61000-3-3, EN55014-1, EN55014-2</b>	Vrsta..... <b>A</b> Širina reza..... <b>B</b> Brzina rotacije sečiva..... <b>C</b> Garantovani nivo jačine zvuka..... <b>D</b> Izmereni nivo jačine zvuka..... <b>E</b> Nivo..... <b>F</b> Vrednost..... <b>G</b> Težina..... <b>H</b>	

A	MLite 28
B	28 cm
C	7,250 RPM
D	96 dB (A)
E	96 dB (A)
F	84.1 dB(A)
G	1.21 m/s <sup>2</sup>
H	4.5 kg

Newton Aycliffe, 9/12/2004  
 M. Bowden,  
 Research & Development Director



**PL - INSTRUKCJA OBSŁUGI**

Podkaszarka  
Micro Lite  
Wydanie I, 2004  
SWW 0673-91

**DANE TECHNICZNE**

Napięcie zasilania	230 V, 50 Hz
Moc silnika	1100 W
Klasa izolacji	II
Ciężar	4,5 kg
Szerokość koszenia	28 cm
Wysokość koszenia	2 (10 - 30 mm)

**UWAGA !**

Znaki bezpieczeństwa na urządzeniu muszą być widoczne i utrzymywane w czystości. W razie ich uszkodzenia lub utraty należy je wymienić lub uzupełnić w autoryzowanym punkcie serwisowym.

**UWAGA !**

Podkaszarka przeznaczona jest wyłącznie do zastosowań przydomowych i nie może być używana w innym celu niż podkaszanie trawy i krawędziowanie brzegów trawnika.

Firma Flymo zastrzega sobie możliwość zmiany parametrów technicznych w ramach ciągłego unowocześniania urządzeń.

Druki gwarancji wydawane są przy zakupie urządzenia. Przepisy gwarancyjne określone są na Karcie Gwarancyjnej.

**CZ - Technická data**

Motor:	elektrický
Napětí:	230 V, 50 Hz
Příkon motoru:	1100W
Šířka sekání:	28cm
Výška sečení	2 (10-30)mm
Hmotnost:	4.5 kg

