

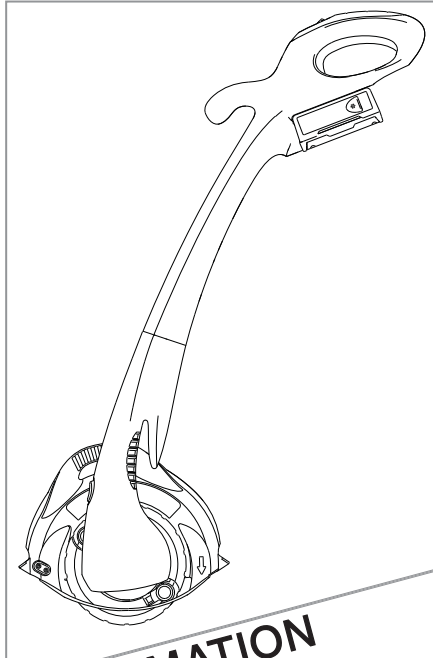

Contour Cordless XT

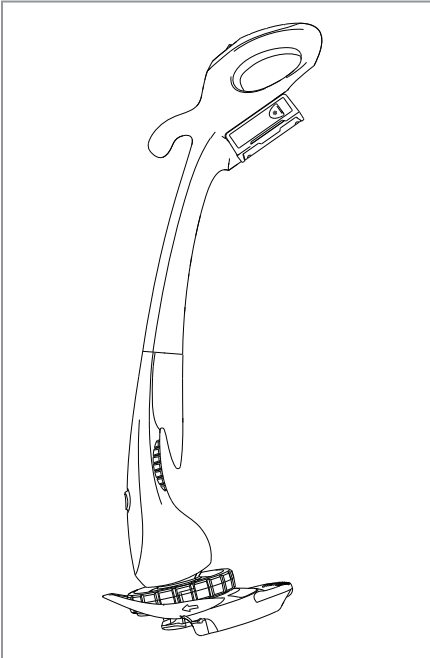

Original Instructions



IMPORTANT INFORMATION
Read before use
& retain for future reference

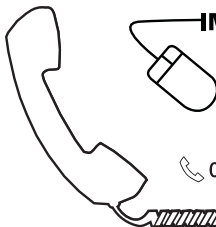

IMPORTANT Please register your product warranty on line.

To register your warranty and for all your parts requirements please visit

www.flymo.com

For all other enquiries

☎ 0844 844 4558 **UK** 1800 882 350 **ROI**

✉ customer.services@husqvarna.co.uk

Carton Contents

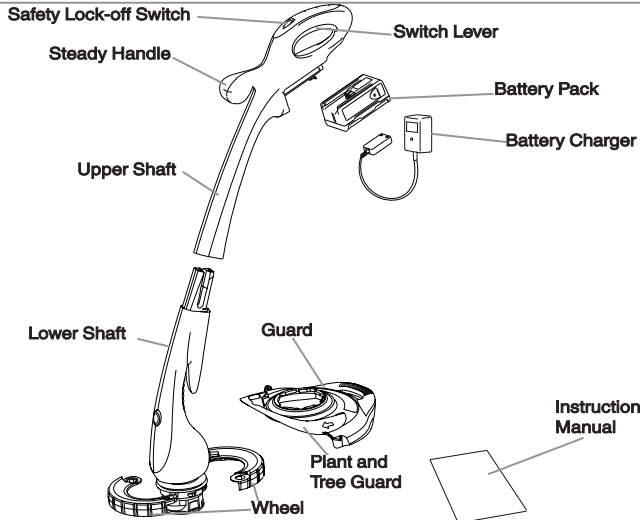

IMPORTANT! Please check the contents of the carton are correct **BEFORE** assembling your new Flymo product.
IF ANY PARTS ARE MISSING CONTACT:-

Husqvarna UK Ltd. Customer Service Department direct
 Telephone : 0844 844 4558 **UK**

1800 882 350 **ROI**

FAX : 01325 302530

Safety



WARNING. When using the product the safety rules must be followed. For your own safety and that of bystanders please read these instructions before operating the product. Please keep the instructions safe for later use.

Explanation of Symbols on the product



Warning



Read the user instructions carefully to make sure you understand all the controls and what they do.



Keep others, including children, pets and bystanders outside the 10 metre hazard zone. Stop the trimmer immediately if you are approached.



The use of eye protection is recommended to protect against objects thrown by the cutting line.



To avoid the possibility of electric shock, do not use in damp or wet conditions.



Switch off! Remove battery pack before adjusting or cleaning.

Warning: The cutting line continues to rotate after the machine has been switched off.

General

1. This product is not intended for use by persons (including children) with reduced physical, sensory or mental capabilities, or lack of experience and knowledge, unless they have been given supervision or instruction concerning the use of the product by a person responsible for their safety. Children should be supervised to ensure that they do not play with the product. Local regulations may restrict the age of the operator.
2. Never allow children or people unfamiliar with the instructions to use the machine.
3. Stop using the machine while people, especially children, or pets are nearby.
4. Only use the trimmer in the manner and for the functions described in these instructions.
5. Never operate the trimmer when you are tired, ill or under the influence of alcohol, drugs or medicine.
6. The operator or user is responsible for accidents or hazards occurring to other people or their property.

Battery

Cordless Battery Powered Products require special care.

1. **AVOID ACCIDENTAL STARTING. KEEP HANDS AND FINGERS AWAY FROM THE SWITCH LEVER WHILE CARRYING THE TRIMMER.**
2. Always charge the product indoors and store in a cool dry place - out of the reach of children.
3. Use only the charger provided with your unit. Use of any other charger could permanently damage the battery and the trimmer.
4. Use the charger with standard domestic household electrical outlets only.
5. Do not abuse the charger or charger cord.
6. Do not use the charger if the charger or charger cord is damaged.
7. Use the charger indoors only.
8. Do not use the charger outdoors.
9. Store and charge this unit in a cool, dry, well ventilated location and out of the reach of children.

- Do not charge the battery or use the unit in an explosive or corrosive environment. Avoid areas where flammable liquids or gases are present to avoid creating a fire or explosion.
- Do not attempt to repair the unit including the battery. Nylon line replacement and cleaning the unit are the only items suitable for user maintenance.
- Do not insert any object into the motor area. Keep free of debris to avoid overheating.
- Do not incinerate or mutilate the battery. Batteries contain hazardous chemicals. Dispose of properly.

Preparation

- While using your product always wear substantial footwear and long trousers.
- Before using the machine and after any impact, check for signs of wear or damage and repair as necessary.
- Inspect the area to be cut before each use. Remove all objects such as stones, broken glass, nails, wire, string etc, which can be thrown or become entangled in the trimmer head.
- Before use, inspect the area for wildlife, especially hedgehogs.
- Check that the cutting head, spool and cap are fitted correctly.

Use

- Use the trimmer only in daylight or good artificial light.
- Avoid operating your trimmer in wet grass, where feasible.
- Take care in wet grass, you may lose your footing.
- On slopes, be extra careful of your footing and wear non-slip footwear.
- Do not walk backwards when trimming, you could trip. Walk, never run.
- Never operate the trimmer with damaged guards or without guards in place.

- Never fit metal cutting elements.
- Keep hands and feet away from the cutting means at all times and especially when switching on the motor.
- Keep cutting head below waist level.
- Do not lean over the trimmer guard whilst trimming or edging - objects may be thrown by the cutting line.
- Beware of cut-off pieces of nylon line ejected during use.
- If you hit an object, do not use your trimmer until you are sure that the entire trimmer is in a safe operating condition.
- If the trimmer starts to vibrate abnormally, check immediately. Excessive vibration can cause injury.

Maintenance and storage

- Keep all nuts, bolts and screws tight to be sure the trimmer is in safe working condition.
- Replace worn or damaged parts for safety.
- Only use the replacement cutting line specified for this product.
- Only use replacement parts and accessories recommended by Husqvarna UK Ltd.
- After any maintenance in dealing with the cutting line, always return the product to its normal operating position before switching on.
- To avoid the risk of injury keep fingers and hands clear of the line cutter on the leading edge of the guard.
- Clean unit with a dry cloth. Never use metal objects to clean the unit.
- Inspect and maintain the trimmer regularly. Any repairs must be carried out by an authorised repairer.
- Store the product in a cool, dry place and out of reach of children. Do not store the product outdoors.
- Allow the product to cool for at least 30 minutes before storing.

Battery Pack

Battery Pack Care

- If over a period of time the Battery Pack quickly runs down after a full 6 hour charging period, a replacement Battery Pack is needed.
- There will be some charge present in the Battery Pack but to ensure maximum running time, charge your Battery Pack for 6 hours before first use.
- To prevent permanent Battery Pack damage, never store in a discharged condition.
- Contact your local approved service centre/dealer/distributor for a replacement Battery Pack and for safe disposal of your old Battery Pack.
- Battery**
18 Volt 1.6 AmpHour "High Power"
Sealed for Life No maintenance required

- IMPORTANT**
DISPOSE OF YOUR OLD BATTERY PACK SAFELY
DO NOT CUT OPEN, BURN OR INCINERATE.

Winter Storage

- Fully charge for 6 hours before winter storage.
- Re-charge the Battery Pack every 3 to 4 months for a full 6 hour charging period to top up the battery charge during winter storage.
- Avoid extended storage without re-charge.
- Store in a cool dry place.

For further information on Battery Pack replacement contact Husqvarna UK Ltd. Customer Service direct:- Telephone: 0844 844 4558 UK 1800 882 350 ROI Fax: 01325 302530

Assembly Instructions

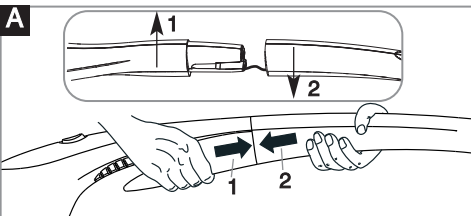

Shaft Assembly (A)

- Locate the lower shaft (A1) into the upper shaft (A2).
 - Grasp firmly and hold steady the lower shaft. Locate the upper shaft and snap together firmly.
- The unit is correctly assembled when the gap between the upper and lower shaft has been closed.

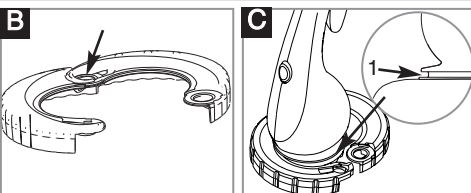

Wheel Assembly (B) & (C)

- Fix the 2 halves of the wheel together as illustrated in fig B.
- Attach the wheel to the trimmer making sure that it is located into the groove on the trimmer head (C1).
- Clip the wheel together on the other side, making sure it is secure.
- The wheel should turn freely.

Assembly Instructions cont'

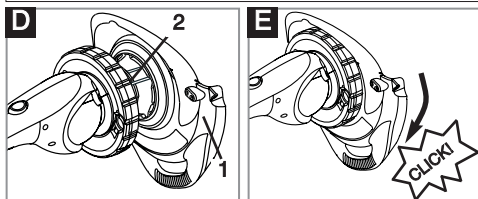

Safety Guard Assembly (D) & (E)

1. Locate the safety guard (**D1**) over the cutting head (**D2**). Ensure the nylon line is fed through the hole in the safety guard as illustrated in **fig D**.
 2. Push into location and turn safety guard in the direction illustrated in **Fig E**, until a click is heard and the safety guard is securely locked in position.
- **ENSURE THE SAFETY GUARD IS SECURELY IN PLACE BY ATTEMPTING TO TWIST GUARD.**

Charging the Battery Pack

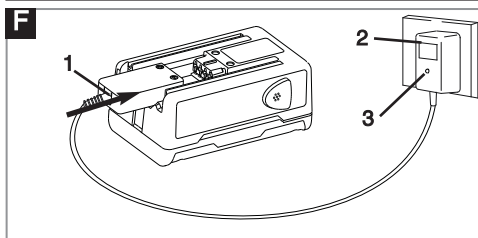

Initial Charging Procedure

1. Use the charger indoors only.
2. Ensure the charger is not exposed to moisture. Keep the charger and the Battery Pack dry at all times. Keep the charger well ventilated during charging.
3. Attach the charger connector (**F1**) to the Battery Pack.
4. Plug the charger (**F2**) into a suitable household electrical wall socket and switch on.
5. The red indicator lamp (**F3**) glows continuously during charging.
6. Full charge will be achieved in 6 hours after which the indicator lamp on the charger (**F3**) will turn to green. During charging the charger becomes warm. This is normal and means the charger is operating correctly.

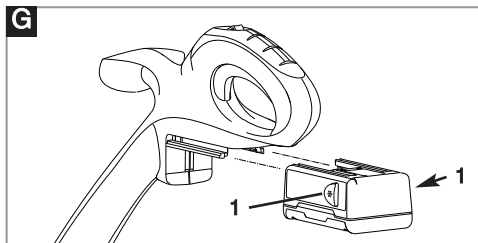

Re-Charging the Battery Pack

1. Re-charge the Battery Pack as soon as the cutting power of your trimmer begins to die and slow down.
2. Avoid running the Battery Pack into "deep" discharge, i.e. avoid flattening the Battery Pack completely.
3. Follow the procedure outlined in the **Initial Charging Procedure**.
4. Charging the Battery Pack according to these instructions should ensure maximum battery life.

Battery Pack Assembly (G)

1. Attach the Battery Pack as illustrated in **Fig G**, ensuring that it clicks into position and is located firmly.
2. To remove, press the two buttons (**G1**) on either side of the Battery Pack and slide off.

How to trim and edge

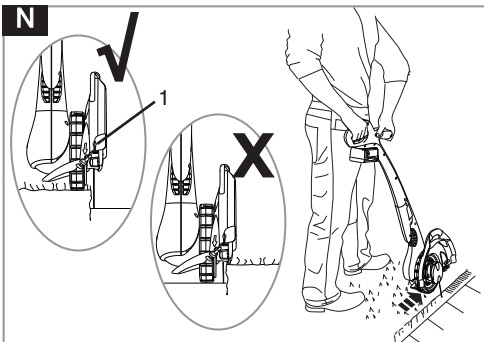
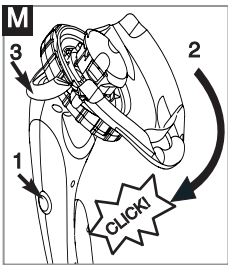
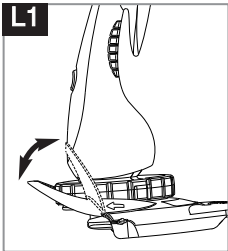
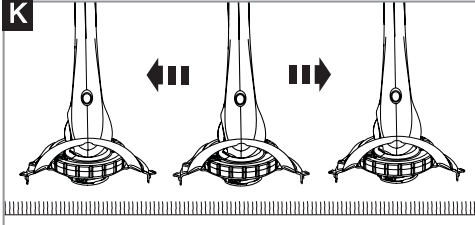
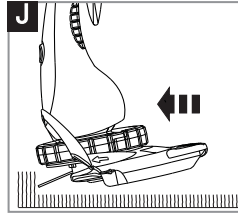
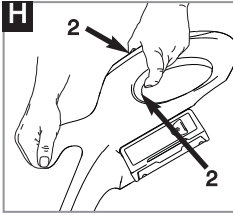

WARNING

- The use of eye protection is recommended. Do not lean over the trimmer whilst trimming or edging, objects may be thrown by the cutting line. Do not allow cutting head to rest on the ground. Do not overload your trimmer. Overloading can be avoided by making sure the motor speed does not drop unduly. REMOVE THE BATTERY PACK BEFORE ATTEMPTING ANY MAINTENANCE OR ADJUSTMENT.
- BEFORE USE Make sure that the cutting line is fed out.
- Make sure motor is up to full speed before trimming or edging.

How to trim

1. Hold as illustrated in Fig H.

2. To start, squeeze the safety lock-off (H1) and then the switch lever (H2).

3. Cut with nylon line at an angle using the tip. See Fig J.

4. Swing trimmer in and out of the cutting area taking small cuts (K)

5. Line is fed out automatically every time the trimmer head stops rotating and returns to operating speed.

- Extra line can be fed out manually as described in Manual line feed

6. To stop your trimmer release the switch lever. The cutting head will stop in approximately one second.

Using the Plant & Tree Guard

The Plant and Tree Guard (L1) allows the trimming of grass close to plants and trees without damaging them with the cutting line.

1. Flip the guard down as illustrated in Fig L1.

2. Use the trimmer around trees (L2) and near plants.

How to edge

1. To convert to edging mode, press button (M1) and twist head (M2). An audible "click" will confirm that the head is locked.

2. Hold as illustrated in Fig H.

3. To start, squeeze the safety lock-off (H1) and then the switch lever (H2).

4. Rest edger on wheel for extra stability and line up the edge of the lawn with the two indicators on the guard (N1). Edge in direction indicated in Fig N.

5. To stop your trimmer release the switch lever.

6. To return to trimming mode, press button and twist head back the opposite way. An audible "click" will confirm that the head is locked.

- When edging, ensure that the edging wheel is always resting on the grass (and not on the path/driveway)

Auto Line Feed System

P

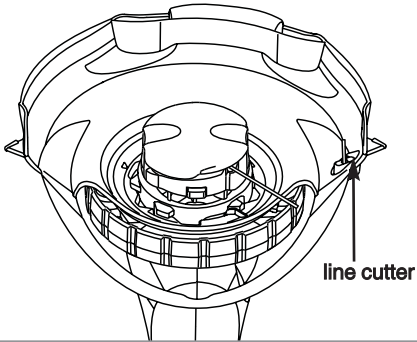

How the automatic line feed works (P)

1. When initially switching on the trimmer, a small length of line is fed out.
2. A 'clattering' noise will be heard when the nylon line hits the line cutter. **DO NOT BE ALARMED this is quite normal.** After approximately 5 seconds the line will be cut to the correct length and the noise will reduce as the motor reaches full speed.
 - **Make sure the motor is up to full speed before trimming or edging.**
3. If the noise of the nylon line being cut cannot be heard, more line will need to be fed out.
4. To feed more line, it is first necessary to allow the motor to stop completely, then re-start, allowing the motor to reach full speed.
5. Repeat step 4. until you hear the line hitting against the cutter. (**Do not repeat this procedure more than 6 times**)
6. If problems are experienced with the automatic line feed refer to Fault Finding Chart.

Manual line feed

Q

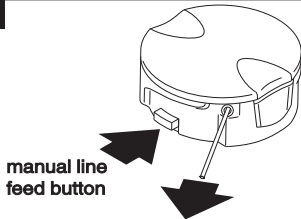

To manually feed the nylon line (Q)

1. If required line can be fed out manually.
2. To operate, press and release manual line feed button, whilst gently pulling on the line until it reaches the line cutter.
3. If the line extends past the line cutter, too much line has been fed out.
4. If too much line is fed out, remove the spool cap and click spool anti-clockwise until the line is at the desired length.

Cutting Head

To remove spool cap

1. Press and hold in the two cap release latches. (R).
2. Pull cap away from the spoolholder. (R).

When refitting the spool cap

1. Keep all areas of the cap and spoolholder clean. Failure to do so may prevent the cap being securely located in the spoolholder.
2. Replace the cap, **pressing firmly DOWN** towards the spoolholder to ensure cap is fully located.
3. Check that the cap is correctly fitted by trying to remove it without depressing the two latches.

To replace nylon line.

For your convenience it is recommended you buy spool and line complete. Nylon line only is also available. Both are available from Husqvarna UK Ltd. stockists.

To fit spool and line complete:

1. Remove old spool.
2. Place new spool into spoolholder with **cut out area of the spool in line with eyelet** as shown in figure S.
3. Release line from cleat and feed line through eyelet (S).
 - **Ensure spool is fully located by gently rotating it during fitment, whilst keeping the spoolholder steady.**
4. Refit the cap.

To fit nylon line only:

- **Remember!** Your product is designed to use only nylon line with a **maximum diameter of 1.5mm**. Use only genuine Flymo nylon line.
1. Take approximately 10 metres of line. Insert 15mm of line into the hole in the spool (T) and wind line in the direction of the arrows on the top of the spool. Leave approximately 100mm of line unwound and place into cleat as illustrated in figure T1.
 2. Care should be taken to ensure that the line is neatly coiled on the spool. Failure to do so will impair the efficiency of the automatic line feed.
 3. Then fit spool as described in 'To fit spool and line complete', section above.
 - **Always return the product to its normal operating position before switching on.**

R

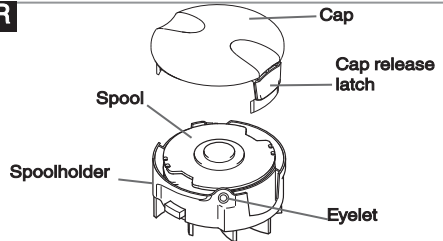

S

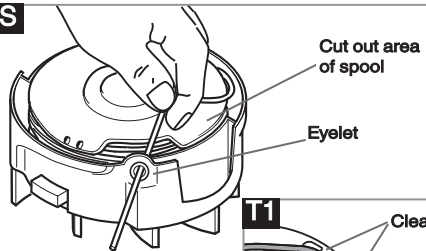

T

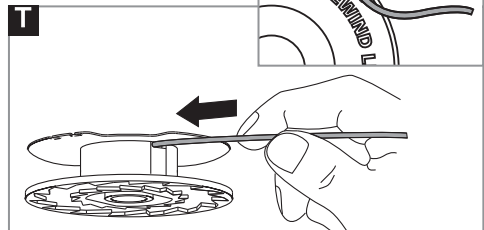

Maintenance

- **WARNING**

Remove the Battery Pack before attempting any maintenance or adjustment. Cutting head continues to rotate after the trimmer has been switched off. Keep fingers and hands clear of the line cutter on leading edge of guard.

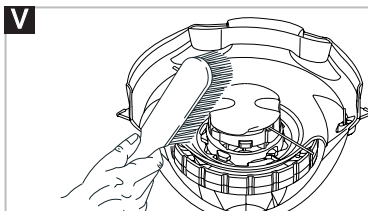

Caring for your Product

After you have finished using your product, follow the procedure below:

1. Never clean your trimmer with water, cleaning fluids, or solvents, just remove debris with a suitable tool, a soft brush or dry cloth.
2. Using a soft brush, clean around the inside of the safety guard, the cutting head (V) and the motor housing air vents. (W)
3. Remove the wheel by pressing one of the buttons. Clean the wheel and groove on trimmer head with a soft brush (X & Y).
4. Attach wheel as described in **Wheel Assembly**.
5. Inspect the trimmer carefully, especially the parts of the cutting head.
6. If your trimmer is damaged in any way contact your local Husqvarna UK Ltd. approved service centre.

- **Never use a damaged trimmer.**

Storage

1. Store in a cool, dry place and out of reach of children. Do not store outdoors.
2. Allow the product to cool for at least 30 minutes before storing.

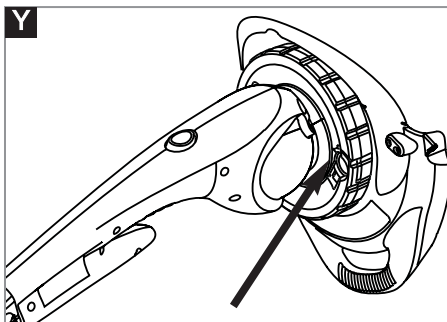
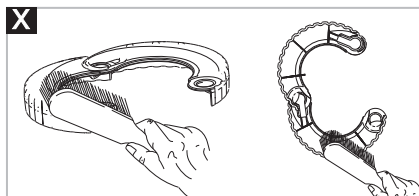
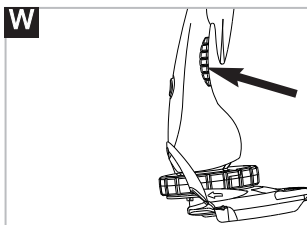

Fault Finding Chart

WARNING Remove the Battery Pack before attempting any maintenance or adjustment.

FAULT	CHECK	RESPONSE	ACTION
LINE NOT FEEDING OR LINE TOO SHORT OR TRIMMER VIBRATES	Is the automatic line feed working?	No	Manually feed out line. SEE "MANUAL LINE FEED"
	Is the line fed out and visible? Has line been removed from cleat?	No	Remove cap and spool, free line and re-fit spool and cap. SEE "CUTTING HEAD"
	Is the manual line feed working?	No	The line may be jammed on the spool. Rewind line to remove crossed loops. Check that line is in correct section of spool.
CONTINUOUS CLATTERING NOISE	Has the motor reached full speed before use?	No	Allow the motor to reach full speed before use.
	Has too much line been fed out?	Yes	SEE "MANUAL LINE FEED"
	Is the line cutter missing from the safety guard?	Yes	Contact your local approved Service Centre or Husqvarna UK Ltd. Customer Service.
LINE SNAPS CONTINUOUSLY	Are you using the trimmer correctly?	?	Only use tip of nylon line to trim. SEE "How to trim and edge"
	Is the line jamming on the spool?	Yes	Rewind the line on the spool, if symptoms still persist, change spool and line.
WHEEL STOPS TURNING	Clean wheel and groove on trimmer head.		SEE "MAINTENANCE"
IF NONE OF THE ABOVE OR IF FAULT PERSISTS	Contact Husqvarna UK Ltd. Customer Service Telephone : 0844 844 4558 UK 1800 882 350 ROI		

Replacement Parts

Spool and Line

Reference no.:

FLY047

Part no.:

510747890

Environmental Information

- Awareness of the environment must be considered when disposing of 'end-of-life' product.
- If necessary, contact your local authority for disposal information.

BATTERY DISPOSAL

- The battery must be removed from the product before disposal (See Battery Replacement Section)
- This product contains a NiMH battery and should not be discarded with normal household waste at the end of its life.
- The battery should be taken to an Authorised Service Centre or your local Recycling Station.
- Do NOT dispose of battery to water.
- NiMH batteries can be harmful and should be disposed of through the recognised recycling facility in accordance with European Regulations.
- Do NOT incinerate.



The symbol on the product or on its packaging indicates that this product may not be treated as household waste. Instead it shall be handed over to the applicable collection point for the recycling of electrical and electronic equipment.

By ensuring this product is disposed of correctly, you will help prevent potential negative consequences for the environment and human health, which could otherwise be caused by inappropriate waste handling of this product. For more detailed information about recycling of this product, please contact your local council office, your household waste disposal service or the shop where you purchased the product.

Service Recommendations

- Your product is uniquely identified by a silver and black product rating label.
- We strongly recommend that your product is serviced at least every twelve months, more often in a professional application.

Guarantee & Guarantee Policy

If any part is found to be defective due to faulty manufacture within the guarantee period, Husqvarna UK Ltd., through its Authorised Service Repairers will effect the repair or replacement to the customer free of charge providing:

- (a) The fault is reported directly to the Authorised Repairer.
 - (b) Proof of purchase is provided.
 - (c) The fault is not caused by misuse, neglect or faulty adjustment by the user.
 - (d) The failure has not occurred through fair wear and tear.
 - (e) The machine has not been serviced or repaired, taken apart or tampered with by any person not authorised by Husqvarna UK Ltd..
 - (f) The machine has not been used for hire.
 - (g) The machine is owned by the original purchaser.
 - (h) The machine has not been used commercially.
- * This guarantee is additional to, and in no way diminishes the customers statutory rights.

Failures due to the following are not covered, therefore it is important that you read the instructions contained in this Operator's Manual and understand how to operate and maintain your machine:

Failures not covered by guarantee

- * Replacing Nylon Line.
- * Failures as a result of not reporting an initial fault.
- * Failures as a result of sudden impact.
- * Failures as a result of not using the product in accordance with the instructions and recommendations contained in this Operator's Manual.
- * Machines used for hire are not covered by this guarantee.
- * The following items listed are considered as wearing parts and their life is dependent on regular maintenance and are, therefore not normally subject to a valid warranty claim: Nylon Line, Spool and Line.

* Caution!

Husqvarna UK Ltd. does not accept liability under the warranty for defects caused in whole or part, directly or indirectly by the fitting of replacement parts or additional parts that are not either manufactured or approved by Husqvarna UK Ltd., or by the machine having been modified in any way.

EC Declaration of Conformity

Husqvarna AB, 561 82, Huskvarna, Sweden

Declare under our sole responsibility that the product(s):

Category.....**Battery Lawn Trimmer**
 Type(s)**CCT250-3**
 Identification of Series.....**See Product Rating Label**
 Year of Construction.....**See Product Rating Label**

Conforms to the essential requirements & provisions of the following EC Directives:

2006/42/EC, 2004/108/EC, 2000/14/EC

based on the following EU harmonized standards applied:

EN60335-1, EN60335-2-91, EN60335-2-29, EN50366, EN55014-1, EN55014-2, EN61000-3-2, EN61000-3-3

The maximum A weighted sound pressure level L_{pA} at the operator's position, recorded on a sample of the above product(s) corresponds to the **Level** given in the table.

The maximum hand / arm vibration weighted value measured according to EN ISO 5349 on a sample of the above product(s) corresponds to the **Value** a_{h1} given in the table.

2000/14/EC: The Measured Sound Power L_{WA} & Guaranteed Sound Power L_{WA} values are according to the tabulated figures.

Conformity Assessment Procedure..... Annex VI
 Notified Body..... Intertek, Cleeve Road
 Leatherhead, Surrey
 KT22 7SB, England

Newton Aycliffe 26/10/2010
 P. Lameli
 Global R&D Director - Hand held
 Husqvarna UK Ltd.
 Keeper of technical documentation



Type	CCT250-3
Width of Cut (cm)	25
Speed of Rotation of Cutting Device (rpm)	8,500
Measured Sound Power L_{WA} (dB(A))	90
Guaranteed Sound Power L_{WA} (dB(A))	96
Level (dB(A))	80.4
Uncertainty (dB(A))	2.5
Value a_{h1} (m/s ²)	2.19
Uncertainty K of a_{h1} (m/s ²)	1.5
Weight (Kg)	2.1

Our policy of continuous improvement means that the specification of products may be altered from time to time without prior notice. **Copyright © 2010 Flymo S.A. All rights reserved. Flymo® and other product and feature names are registered or unregistered trademarks of Flymo S.A.**

Husqvarna AB
 561 82
 Huskvarna
 Sweden

5773748-01

