

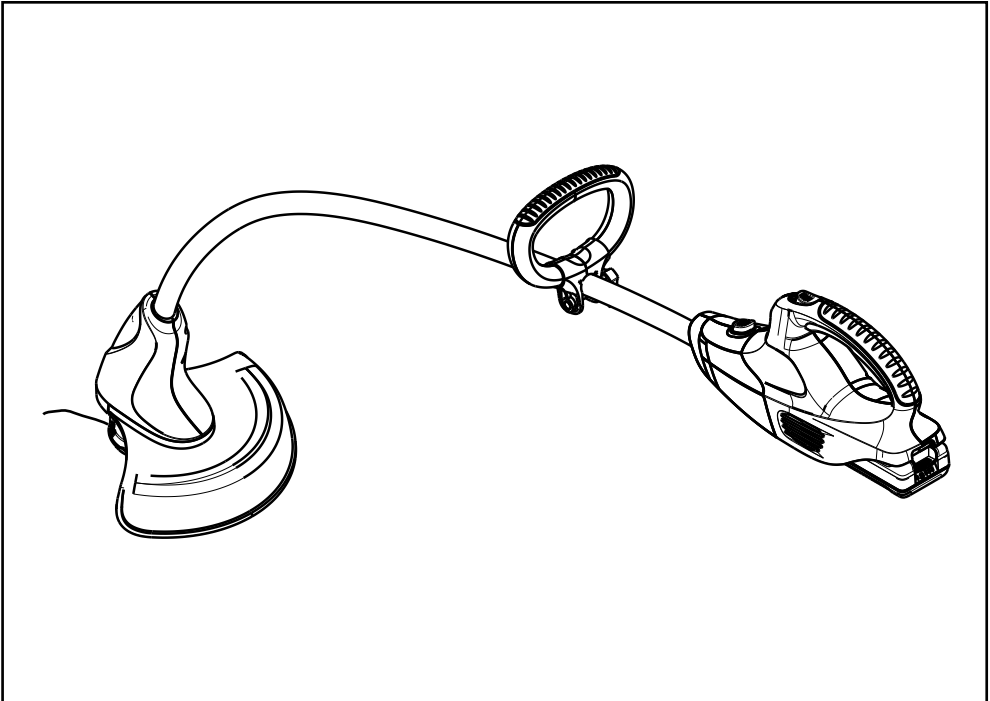

C-Li 20VGT



EN Operator's manual 5

WARNING

IMPORTANT INFORMATION
Read before use
& retain for future reference

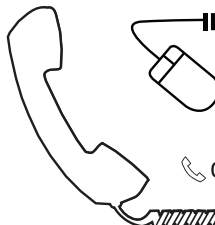

IMPORTANT Please register your product warranty on line.

To register your warranty and for all your parts requirements please visit

www.flymo.com

For all other enquiries

☎ 0344 844 4558 **UK** 1800 882 350 **ROI**

✉ customer.services@husqvarna.co.uk

1	2	3	4	5	6	7
8	9	10	11	12	13	14
15	16	17	<p>Use only nylon line with a diameter up to 0.065" (1.65mm).</p> <p>Utilisez uniquement une ligne en nylon d'un diamètre maximal de 0,065 po (1,65 mm).</p>			

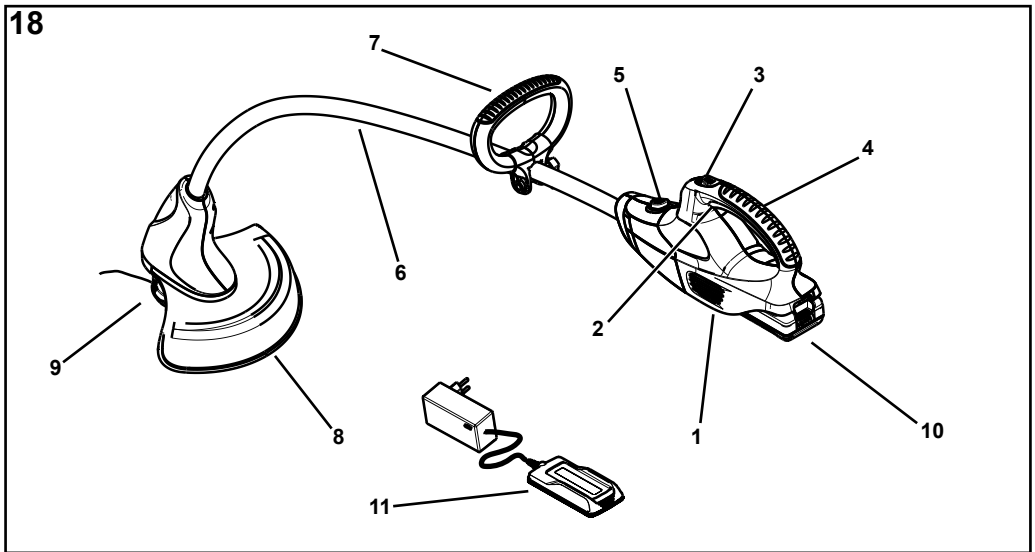

CAUTION	ATTENTION
<p>To reduce risk of injury, read instruction manual. Use only original Flymo 20v rechargeable Lithium-Ion batteries. Other types of batteries may burst causing personal injury and damage. Risk of electric shock. Do not expose to liquid, vapor, or rain. Do not interconnect output terminal. For indoor use only.</p> <p>Para reducir el riesgo de lesiones, lea el manual de instrucciones. Utilice únicamente baterías recargables de iones de litio originales de Flymo 20v. Otros tipos de baterías pueden reventar causando lesiones personales y daños. Riesgo de shock eléctrico. No lo exponga a líquidos, vapores o lluvia. No interconecte el terminal de salida. Sólo para uso en interiores.</p>	<p>Pour réduire le risque de blessure, lisez le manuel d'instructions. Utilisez uniquement des batteries Lithium-Ion rechargeables Flymo 20v d'origine. D'autres types de piles peuvent éclater, causant des blessures et des dommages. Risque de choc électrique. Ne pas exposer au liquide, à la vapeur ou à la pluie. Ne pas interconnecter le terminal de sortie. Pour une utilisation en intérieur uniquement.</p>

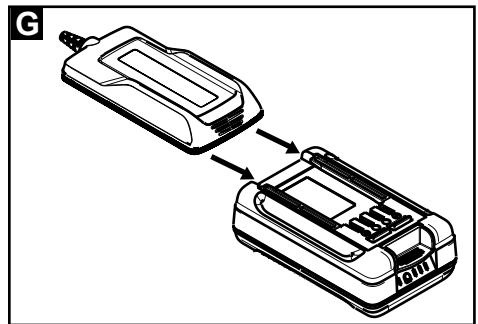
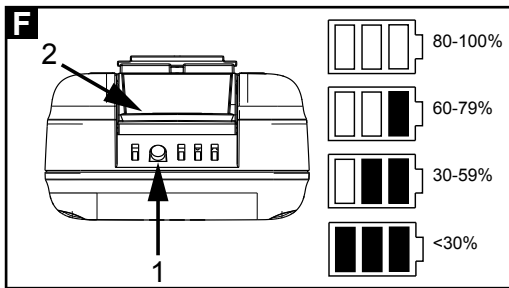
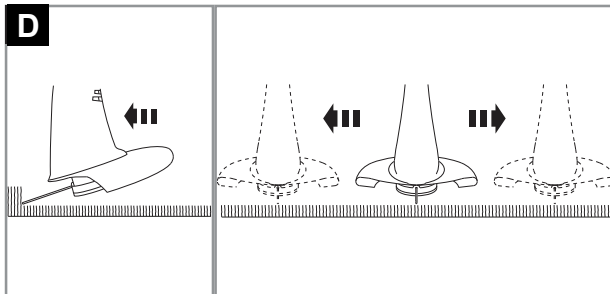
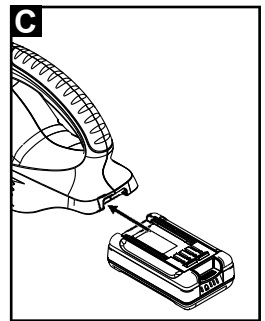
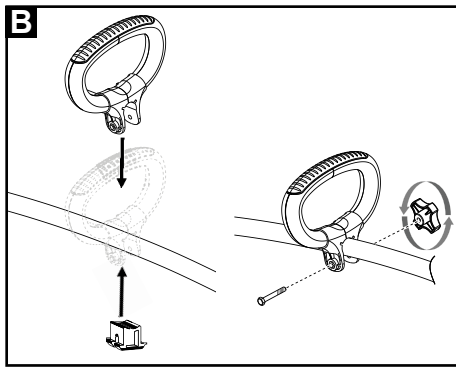
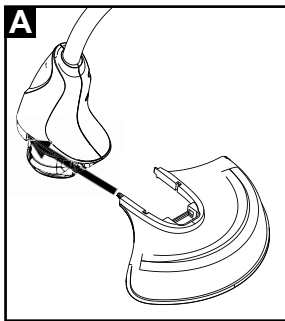

H

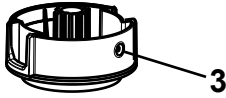
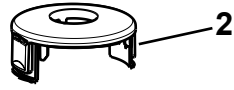

4

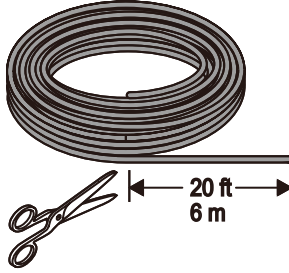

5

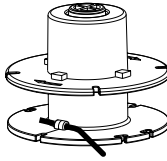

6

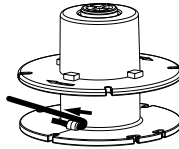

7

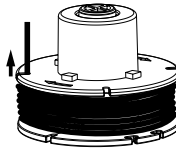

IDENTIFICATION OF SYMBOLS

- **WARNING!** This power tool can be dangerous! Careless or incorrect use can result in serious or fatal injury to the operator or others. **(Picture 1)**
- Please read the operator's manual carefully and make sure you understand the instructions before using the product. **(Picture 2)**
- Always wear approved eye protection. **(Picture 3)**
- Wear hearing protection that provides adequate noise reduction. **(Picture 4)**
- Remove the battery pack before you do maintenance. **(Picture 5)**
- Do not expose to rain. **(Picture 6)**
- Do not wear jewelry, loose clothing, or clothing with loosely hanging straps, ties, tassels, etc. They can be caught in moving parts. **(Picture 7)**
- Always wear heavy, long pants, long sleeves, boots, and gloves. **(Picture 8)**
- Secure hair above shoulder length. **(Picture 9)**
- The product or packaging cannot be handled as domestic waste. The product and packaging must be submitted to an appropriate recycling station for the recovery of electrical and electronic equipment. **(Picture 10)**
- Guaranteed sound power level. **(Picture 11)**
- The product agrees with the applicable EC directives. **(Picture 12)**
- Material may ricochet back toward the operator. **(Picture 13)**
- Keep children, pets and bystanders at a safe distance when using your product. **(Picture 14)**
- Direction of rotation. **(Picture 15)**
- Max speed of output axle, rpm. **(Picture 16)**
- Use only specified trimmer head, spool, and recommended trimmer line. Never use blades, flailing devices, wire, rope, string, etc. This attachment is designed for line trimmer use only. Failure to follow these instructions may result in serious injury. **(Picture 17)**

KNOW YOUR PRODUCT

See **Picture 18**

1. Powerhead
2. Trigger
3. Trigger lockout
4. Rear handle
5. Attachment release button
6. Shaft
7. Assist handle
8. Cutting attachment guard
9. Trimmer head
10. Battery pack
11. Charger

SAFETY

IMPORTANT • READ CAREFULLY BEFORE USE • KEEP FOR FUTURE REFERENCE

GENERAL POWER TOOL SAFETY WARNINGS

⚠ WARNING Read all safety warnings and all instructions. Failure to follow the warnings and instructions may result in electric shock, fire and/or serious injury.

Save all warnings and instructions for future reference.

The term "power tool" in the warnings refers to your mains-operated (corded) power tool or battery-operated (cordless) power tool.

Work area safety

- **Keep work area clean and well lit.** Cluttered or dark areas invite accidents.
- **Do not operate power tools in explosive atmospheres, such as in the presence of flammable liquids, gases or dust.** Power tools create sparks which may ignite the dust or fumes.
- **Keep children and bystanders away while operating a power tool.** Distractions can cause you to lose control.

Electrical safety

- **Power tool plugs must match the outlet. Never modify the plug in any way. Do not use any adapter plugs with earthed (grounded) power tools.** Unmodified plugs and matching outlets will reduce risk of electric shock.
- **Avoid body contact with earthed or grounded surfaces, such as pipes, radiators, ranges and**

refrigerators. There is an increased risk of electric shock if your body is earthed or grounded.

- **Do not expose power tools to rain or wet conditions.** Water entering a power tool will increase the risk of electric shock.
- **Do not abuse the cord. Never use the cord for carrying, pulling or unplugging the power tool. Keep cord away from heat, oil, sharp edges or moving parts.** Damaged or entangled cords increase the risk of electric shock.
- **When operating a power tool outdoors, use an extension cord suitable for outdoor use.** Use of a cord suitable for outdoor use reduces the risk of electric shock.
- **If operating a power tool in a damp location is unavoidable, use a ground fault circuit interrupter (GFCI) protected supply.** Use of a GFCI reduces the risk of electric shock.

Personal safety

- **Stay alert, watch what you are doing and use common sense when operating a power tool. Do not use a power tool while you are tired or under the influence of drugs, alcohol or medication.** A moment of inattention while operating power tools may result in serious personal injury.
- **Use personal protective equipment. Always wear eye protection.** Protective equipment such as dust mask, non-skid safety shoes, hard hat, or hearing protection used for appropriate conditions will reduce

personal injuries.

- **Prevent unintentional starting. Ensure the switch is in the off-position before connecting to power source and/or battery pack, picking up or carrying the tool.** Carrying power tools with your finger on the switch or energising power tools that have the switch on invites accidents.
- **Remove any adjusting key or wrench before turning the power tool on.** A wrench or a key left attached to a rotating part of the power tool may result in personal injury.
- **Do not overreach. Keep proper footing and balance at all times.** This enables better control of the power tool in unexpected situations.
- **Dress properly. Do not wear loose clothing or jewellery. Keep your hair, clothing and gloves away from moving parts.** Loose clothes, jewellery or long hair can be caught in moving parts.
- **If devices are provided for the connection of dust extraction and collection facilities, ensure these are connected and properly used.** Use of dust collection can reduce dust-related hazards.

Power tool use and care

- **Do not force the power tool. Use the correct power tool for your application.** The correct power tool will do the job better and safer at the rate for which it was designed.
- **Do not use the power tool if the switch does not turn it on and off.** Any power tool that cannot be controlled with the switch is dangerous and must be repaired.
- **Disconnect the plug from the power source and/or the battery pack from the power tool before making any adjustments, changing accessories, or storing power tools.** Such preventive safety measures reduce the risk of starting the power tool accidentally.
- **Store idle power tools out of the reach of children and do not allow persons unfamiliar with the power tool or these instructions to operate the power tool.** Power tools are dangerous in the hands of untrained users.
- **Maintain power tools. Check for misalignment or binding of moving parts, breakage of parts and any other condition that may affect the power tools operation. If damaged, have the power tool repaired before use.** Many accidents are caused by poorly maintained power tools.
- **Keep cutting tools sharp and clean.** Properly maintained cutting tools with sharp cutting edges are less likely to bind and are easier to control.
- **Use the power tool, accessories and tool bits etc., in accordance with these instructions and in the manner intended for the particular type of power tool, taking into account the working conditions and the work to be performed.** Use of the power tool for operations different from those intended could result in a hazardous situation.

Battery tool use and care

- **Recharge only with the charger specified by the manufacturer.** A charger that is suitable for one type of battery pack may create a risk of fire when used with another battery pack.
- **Use power tools only with specifically designated battery packs.** Use of any other battery packs may create a risk of injury and fire.
- **When battery pack is not in use, keep it away from other metal objects, like paper clips, coins, keys, nails, screws or other small metal objects, that can make a connection from one terminal to another.** Shorting the battery terminals together may cause burns or a fire.

- **Under abusive conditions, liquid may be ejected from the battery; avoid contact. If contact accidentally occurs, flush with water. If liquid contacts eyes, additionally seek medical help.** Liquid ejected from the battery may cause irritation or burns.

Service

- **Have your power tool serviced by a qualified repair person using only identical replacement parts.** This will ensure that the safety of the power tool is maintained.

SAFE OPERATING PRACTICES

Training

- Read the instructions carefully. Be familiar with the controls and the correct use of the machine.
- Never allow children or people unfamiliar with these instructions to use the machine. Local regulations can restrict the age of the operator.
- Keep in mind that the operator or user is responsible for accidents or hazards occurring to other people or their property.

Preparation

- Before use check the supply and extension cord for signs of damage or aging. If the cord becomes damaged during use, disconnect the cord from the supply immediately. **DO NOT TOUCH THE CORD BEFORE DISCONNECTING THE SUPPLY.** Do not use the machine if the cord is damaged or worn.
- Before use, always visually inspect the machine for damaged, missing or misplaced guards or shields.
- Never operate the machine while people, especially children, or pets are nearby.

Operation

- Keep supply and extension cords away from cutting means.
- Wear eye protection and stout shoes at all times while operating the machine.
- Avoid using the machine in bad weather conditions especially when there is a risk of lightning.
- Use the machine only in daylight or good artificial light.
- Never operate the machine with damaged guards or shields or without guards or shields in place.
- Switch on the motor only when the hands and feet are away from the cutting means.
- Always disconnect the machine from the power supply (i.e. remove the plug from the mains, remove the disabling device or removable battery)
 - whenever the machine is left unattended;
 - before clearing a blockage;
 - before checking, cleaning or working on the machine;
 - after striking a foreign object;
 - whenever the machine starts vibrating abnormally.
- Take care against injury to feet and hands from the cutting means.
- Always ensure that the ventilation openings are kept clear of debris.

Maintenance and storage

- Disconnect the machine from the power supply (i.e. remove the plug from the mains, remove the disabling device or removable battery) before carrying out maintenance or cleaning work.
- Use only the manufacturer's recommended replacement parts and accessories.
- Inspect and maintain the machine regularly. Have the machine repaired only by an authorized repairer.

- When not in use, store the machine out of the reach of children.

Recommendation (For mains powered machines and those with an integral charger)

- The machine should be supplied via a residual current device (RCD) with a tripping current of not more than 30 mA.

SAFETY INSTRUCTIONS FOR OPERATION

- Make sure the product is fully assembled before you use it.
- The product can cause objects to eject, which can cause damage to the eyes. Always use an approved eye protection when you operate the product.
- Be careful, a child can come near the product without your knowledge during operation.
- Do not operate the product if there are persons in the work area. Stop the product if a person goes into the work area.
- Make sure that you are always in control of the product.
- Do not use the product if you cannot receive aid if an accident occurs. Always make sure others know when you use the product before you start operation.
- Do not turn with the product before you make sure that no persons or animals are in the safety area.
- Remove all unwanted materials from the work area before you start. If the cutting attachment hits an object, the object can eject and cause injury or damage. Unwanted material can wind around the cutting attachment and cause damage.
- Do not use the product in bad weather, such as fog, rain, strong winds, risk of lightning or other conditions. Dangerous conditions, such as slippery surfaces, can occur because of bad weather.
- Make sure that you can move freely and work in a stable position.
- Make sure that you cannot fall when you use the product. Do not tilt when you operate the product.
- Always hold the product with your two hands. Hold the product on the right side of your body.
- Operate the product with the cutting attachment below your waist.
- Stop the motor before you move the product.
- Do not put down the product with the motor on.
- Before you remove the unwanted materials from the product, stop the motor and wait until the cutting attachment stops. Let the cutting attachment stop before you or an aide remove the cut material.

ADDITIONAL SAFETY INSTRUCTIONS

- Use the product correctly. Injury or death is a possible result of incorrect use. Only use the product for the tasks found in this manual. Do not use the product for other tasks.
- Obey the instructions in this manual. Obey the safety symbols and the safety instructions. If the operator does not obey the instructions and the symbols, injury, damage or death is a possible result.
- Do not discard this manual. Use the instructions to assemble, to operate and to keep your product in good condition. Use the instructions for correct installation of attachments and accessories. Only use approved attachments and accessories.
- Do not use a damaged product. Obey the maintenance schedule. Only do the maintenance work that you find an instruction about in this manual. An approved service center must do all other maintenance work.
- This manual cannot include all situations that can

occur when you use the product. Be careful and use your common sense. Do not operate the product or do maintenance to the product if you are not sure about the situation. Speak to a product expert, your dealer, service agent or approved service center for information.

- Remove the battery pack before you assemble the product, put the product into storage or do maintenance.
- Do not use the product if it is changed from its initial specification. Do not change a part of the product without approval from the manufacturer. Only use parts that are approved by the manufacturer. Injury or death is a possible result of incorrect maintenance.
- This product makes an electromagnetic field. The electromagnetic field can cause damage to medical implants. Speak to your physician and medical implant manufacturer before you operate the product.
- Do not let a child operate the product. Do not let a person, without knowledge of the instructions operate the product.
- Make sure that you always monitor a person, with decreased physical capacity or mental capacity, that uses the product. A responsible adult must be there at all times.
- Lock the product in an area that children and not approved persons cannot access.
- The product can eject objects and cause injuries.
- Obey the safety instructions to decrease the risk of injury or death.
- Do not go away from the product when the motor is on. Stop the motor and make sure that the cutting attachment does not turn.
- The operator of the product is responsible if an accident occurs.
- Make sure that parts are not damaged before you use the product.
- Make sure that you are at a minimum 10 m (30 ft) away from other persons or animals before you use the product. Make sure that a person in adjacent area knows that you will use the product.
- Refer to national or local laws. They can prevent or decrease the operation of the product in some conditions.

VIBRATION EXPOSURE

Exposure to vibrations through prolonged use of power tools could cause blood vessel or nerve damage in the fingers, hands, and joints of people prone to circulation disorders or abnormal swelling. Prolonged use in cold weather has been linked to blood vessel damage in otherwise healthy people. If symptoms occur such as numbness, pain, loss of strength, change in skin color or texture, or loss of feeling in the fingers, hands, or joints, discontinue the use of this power tool and seek medical attention. An anti-vibration system does not guarantee the avoidance of these problems. Users who operate power tools on a continual and regular basis must closely monitor their physical condition and the condition of the power tool.

PERSONAL PROTECTIVE EQUIPMENT

- Always use correct personal protective equipment when you operate the product. The personal protective equipment does not erase the risk of injury. The personal protective equipment decreases the grade of injury if an accident occurs.
- Always use an approved eye protection while you operate the product.
- Do not operate the product with bare feet or with open shoes. Always use heavy-duty slip-resistant boots.
- Use heavy, long pants.

- If it is necessary, use approved protective gloves.
- Use a helmet if it is possible that objects fall on your head.
- Always use approved ear protection while you operate the product. Noise for a long period can cause noise-induced hearing loss.
- Make sure that you have a first aid kit near.

PROTECTIVE DEVICES ON THE PRODUCT

Trigger lockout

The trigger lockout locks the trigger. Push the trigger lockout to release the trigger. When you release the handle, the trigger lockout and the trigger go back to their initial positions.

1. Push the trigger lockout and make sure that it goes back to its initial position when you release it.
2. Push the trigger and make sure that it goes back to its initial position when you release it.

Cutting attachment guard

The cutting attachment guard prevents a loose object to eject in the direction of the operator. Examine the cutting attachment guard for damage and replace it if it is damaged. Only use the approved guard for the cutting attachment.

BATTERY SAFETY

- Only use battery packs from the manufacturer and only charge them in a battery charger from the manufacturer.
- The rechargeable battery packs are only used as a power supply for related cordless products. To prevent injury, the battery pack must not be used as a power source for other devices.
- Do not disassemble, open or shred battery pack.
- Do not keep battery packs in open sunlight or heat. Keep battery packs away from fire.
- Regularly examine the battery pack charger and the battery pack for damage. Damaged or changed battery packs can cause a fire, explosion or risk of injury. Do not repair or open damaged battery packs.
- Do not use a battery pack or product that is defective, changed or damaged.
- Do not change or repair products or the battery pack. Only let your approved dealer do repairs.
- Do not short circuit a cell or battery pack. Do not save battery packs in a box or drawer where they can be short circuited by other metal objects.
- Do not remove a battery pack from its initial package until necessary for operation.
- Do not mechanically shock battery packs.
- If there is a battery leak, do not let the liquid touch the skin or eyes. If you have touched the liquid, clean the area with a large quantity of water and get medical aid.
- Do not use a battery charger other than what is specified for operation with the battery pack.
- Look at the plus (+) and minus (-) marks on the battery pack and product to make sure of correct operation.
- Do not use a battery pack not made for operation with the product.
- Do not mix battery packs of a different voltage or manufacturer in a device.
- Keep battery packs away from children.
- Always purchase the correct battery packs for the product.
- Keep batteries clean and dry.
- Clean the battery pack terminals with a clean dry cloth if they become dirty.
- Secondary battery packs must be charged before use.

Always use the correct battery charger and refer to the manual for correct charging instructions.

- Do not keep a battery pack on continuous charge when not in operation.
- Save the manual to refer to it in the future.
- Only use the battery pack for its necessary operation.
- Remove the battery pack from the product when not in operation.
- Keep the battery pack away from paper clips, keys, nails, screws, or other small metal objects while in operation. This can make a connection between terminals. Shorting the battery pack terminals together can cause burns or a fire.

CHARGER USE AND CARE

- **Before using the charger, read all instructions and cautionary markings for the charger, battery pack, and the product using the battery pack.**
- **Do not allow any liquid to get inside charger.**
- **To reduce the risk of injury, charge only designated batteries.** The charger and battery pack are specifically designed to work together. Other types of batteries may burst, causing personal injury and damage.
- **Under certain conditions, with the charger plugged in to the power supply, the charger can be shorted by foreign material.** Foreign materials of a conductive nature such as, but not limited to, steel wool, aluminum foil, or any buildup of metallic particles should be kept away from charger cavities.
- **Always unplug the charger from the power supply when there is no battery pack in the cavity.**
- **The charger is not intended for any uses other than charging the designated rechargeable batteries.** Any other uses may result in risk of fire, electric shock or electrocution.
- **Do not expose the charger to rain or snow.**
- **Pull by the plug rather than the cord when disconnecting the charger.** This will reduce the risk of damage to the electric plug and cord.
- **Make sure that the cord is located so that it will not be stepped on, tripped over, or otherwise subjected to damage or stress.**
- **Do not operate the charger with a damaged cord or plug.** Have them replaced immediately.
- **Do not operate the charger if it has received a sharp blow, has been dropped, or has been damaged in any other way.** Take it to an authorized service center.
- **Do not disassemble the charger. Take it to an authorized service center when service or repair is required.** Incorrect reassembly may result in a risk of electric shock, electrocution or fire.
- **Disconnect the charger from the outlet before attempting any cleaning.** This will reduce the risk of electric shock. Removing the battery pack will not reduce the risk.
- **Do not attempt to connect 2 chargers together.**
- **The charger is designed to operate on standard household electrical power (120 Volts).** Do not attempt to use it on any other voltage.

Electrical outlets

 **WARNING: Do not touch the terminals of the plug when installing or removing the plug from the outlet.**

Before plugging in the charger, make sure that the outlet voltage supplied is within the voltage marked on the charger's data plate.

Extension cords

Do not use an extension cord unless it is absolutely necessary. Use of improper extension cord could result in risk of fire, electric shock, or electrocution.

⚠ WARNING: Do not touch the terminals of the plug when installing or removing the plug from the extension cord.

When using an extension cord, be sure to use one heavy enough to carry the current that your power tool will draw. An undersized extension cord will cause a drop in line voltage resulting in loss of power and overheating.

MAINTENANCE AND STORAGE

- Remove the battery before carrying out maintenance or cleaning work.
- Use only the manufacturer's recommended replacement parts and accessories.
- Inspect and maintain the product regularly. Have the product repaired only by an authorized repairer.
- When not in use, store the product out of the reach of children.

Cutting attachment

- Do the regular maintenance. Let an approved service

center regularly examine the cutting attachment to do adjustments or repairs.

- The performance of the cutting attachment increases.
- The life of the cutting attachment increases.
- The risk of accidents decreases.
- Only use an approved cutting attachment guard.
- Do not use a damaged cutting attachment.

Grass trimmer head

- Make sure that you wind the grass trimmer line tightly and equally around the drum to decrease the vibration.
- Use only the approved grass trimmer heads and grass trimmer lines.
- Use a correct length of the grass trimmer line. A long grass trimmer line uses more motor power than a short grass trimmer line.
- Make sure that the cutter on the cutting attachment guard is not damaged.
- Soak the grass trimmer line in water for 2 days before you attach the grass trimmer line to the product. This increases the life of the grass trimmer line.

ASSEMBLY

⚠ WARNING! Do not install the battery pack until the power tool is completely assembled.

ASSEMBLING THE ATTACHMENT

Insert the attachment into the powerhead until it clicks into position. Make sure the attachment release button passes completely through the hole.

NOTE: To remove the attachment, press down firmly on the attachment release button while pulling the attachment out of the powerhead.

ASSEMBLING THE GUARD (A)

1. Position the opening of the guard over the trimmer head.
2. Push the guard until it clicks.
3. Make sure the guard is securely in place.

ASSEMBLING THE ASSIST HANDLE (B)

1. Attach the assist handle to the shaft using the knob and bolt provided. Ensure the assist handle is located between the arrows on the shaft.
2. Tighten the knob by turning it clockwise.
3. Make sure the assist handle is securely in place.

OPERATION

BEFORE STARTING

- Make sure you have the proper personal protective equipment.
- Inspect the cleanliness of the power tool. Make sure the handles are dry, clean, and free of oil and grease.
- Inspect for correct alignment of moving parts.
- Inspect for broken or damaged parts. Do not use the power tool if any damage affects safety or operation. Have damage repaired by an authorized service center.
- Install the battery pack.

INSTALLING THE BATTERY PACK (C)

NOTE: The battery pack is not shipped fully charged. It is recommended that the battery pack be fully charged before initial use. With regular use, the battery pack will take 4 hours or less to fully charge. It is recommended that the battery pack be charged every 3 months when the tool is not in use. The battery pack's run time will improve after the third or fourth charge.

1. Align the tongue of the battery pack with the cavity in the powerhead.
2. Grasp the rear handle firmly.
3. Push the battery pack into the powerhead until it locks. The latch button will click when locked into place.

NOTE: Do not use force when inserting the battery

pack. It should slide into place and click.

STARTING AND STOPPING THE TOOL

To start the tool, use your thumb to push the lockout forward. While holding the lockout in the forward position, squeeze the trigger to turn on the tool.

To turn off the tool, release the trigger and lockout. The lockout and trigger must both return to their original positions.

TRIMMING (D)

⚠ WARNING

The use of eye protection is recommended.

Do not lean over the trimmer while trimming or edging, objects may be thrown by the grass trimmer line.

Do not allow trimmer head to rest on the ground.

Do not overload the trimmer.

Remove the battery pack before making adjustments.

1. Cut with grass trimmer line at an angle using the tip.
2. Swing trimmer in and out of the cutting area taking small cuts.

While the string trimmer is operating, the cutting line gets worn down and becomes shorter. This trimmer head automatically feeds additional line to the correct length as it wears down. If the line does not automatically advance,

the grass trimmer line may be tangled or empty. To advance the line, restart the trimmer. Upon starting, the

line will automatically advance.

MAINTENANCE

⚠ WARNING: Remove the battery pack before performing maintenance. Severe injury or death could occur from electrical shock or body contact with moving parts.

CHECKING THE BATTERY PACK CAPACITY (F1)

Press the battery pack power level indicator button. The lights will illuminate according to the battery pack's current power level.

Lights	Battery Pack Power Level
3 Green Lights	80 – 100%
2 Green Lights	60 – 79%
1 Green Light	30 – 59%
No lights	Below 30%. Charge immediately.

REMOVING THE BATTERY PACK (F2)

1. Press in and hold the battery pack release button.
2. Grasp the rear handle and pull the battery pack out of the powerhead.

CHARGING THE BATTERY PACK (G)

⚠ WARNING: Do not use the charger in direct sunlight. Recharge at temperatures between 0°C and 40°C (32°F and 104°F).

⚠ WARNING: If the battery pack is hot, allow it to cool down before recharging.

1. Plug the charger into an AC power outlet.
2. Slide the charger over the battery pack terminals. Make sure the charger and battery pack are fully connected.

When the battery pack is charging, the LED will blink. When the battery pack is fully charged, the LED will stop blinking but will remain illuminated.

Once all charging lights turn green, remove the battery pack from the charger and disconnect the charger from the outlet.

After charging, the battery pack may be stored on the charger, as long as the charger is not plugged in.

Store the battery pack fully charged.

REPLACING THE GRASS TRIMMER LINE (H)

Invert the string trimmer to access the trimmer head.

1. Press and hold in the two spool cap release latches (H2).
2. Pull the spool cap away from the spool housing.
3. Remove the spool (H1) from the spool housing.
4. Cut the length of line to 20 ft (6 m) total length (H4).
5. Insert one end of the grass trimmer line into the hole in the spool approximately 1/4 inch (6.4 mm) (H5).
6. Wind the grass trimmer line clockwise evenly and overlapping the first row and continuing the process until complete (H6).
7. To keep the grass trimmer line from unraveling, hook the grass trimmer line in the retainer (H7).
8. Insert the spool in the spool housing.
9. Insert the end of line through the opening (H3) in the spool housing.
10. Align the tabs on the spool cap with the slots in the spool housing.
11. Push down on the spool cap, locking it to the spool housing.
12. Pull the grass trimmer line from the retainer and through the opening in the spool housing.

STORING THE POWER TOOL

1. Remove the battery pack.
2. Remove debris with a soft brush or dry cloth. Never clean with water, cleaning fluids, or solvents.
3. Use a soft brush to remove debris from the air vents.
4. Inspect the tool carefully. If the tool is damaged in any way, contact an authorized service center. Never use a damaged tool.
5. Store in a cool, dry place and out of reach of children.

STORING THE CHARGER

- Remove debris with a soft brush or dry cloth. Never clean with water, cleaning fluids, or solvents.
- Unplug the charger when there is no battery pack in it.
- Store the charger at normal room temperature. Do not store it in excessive heat.

TROUBLESHOOTING

Starting and running problems

Trouble	Cause	Remedy
The motor fails to start when the trigger is squeezed.	<ol style="list-style-type: none"> 1. Battery pack is not secure. 2. Battery pack is not charged. 	<ol style="list-style-type: none"> 1. Make sure the battery pack is fully secured in the power tool. 2. Charge the battery pack.
The power tool will not start.	<ol style="list-style-type: none"> 1. Attachment not correctly assembled in the powerhead. 2. Battery pack is not secure. 3. Battery pack is not charged. 4. Defective power switch. 	<ol style="list-style-type: none"> 1. Assemble the attachment correctly in the powerhead. 2. Make sure the battery pack is fully secured in the power tool. 3. Charge the battery pack. 4. Call an authorized service center

Grass trimmer line problems

Trouble	Cause	Remedy
<ul style="list-style-type: none"> Grass trimmer line not feeding Grass trimmer line too short Trimmer vibrates 	Bump feed grass trimmer line not working	Manually feed out grass trimmer line
	Grass trimmer line not visible	Remove spool cap and spool, free grass trimmer line and re-install spool and spool cap.
Continuous clattering noise	Motor not reaching full speed before use	Allow the motor to reach full speed before use
	Too much grass trimmer line fed out	Rewind grass trimmer line
	Grass trimmer line cutter missing	Replace grass trimmer line cutter
Grass trimmer line snaps continuously	Incorrect trimming technique	Only use tip of grass trimmer line to trim

TECHNICAL DATA

	unit	C-Li 20VGT
Motor specifications		
Motor type		Brushed
Motor voltage	V (DC)	20
Motor power	W	270
Noise and vibration data		
Equivalent vibration level (ahv, eq) front handle. See Note 1.	m/s ²	3.1
Equivalent vibration level (ahv, eq) rear handle. See Note 1.	m/s ²	1.9
Sound power level, guaranteed (LWA). See Note 2.	dB(A)	96
Sound power level, measured. See Note 2.	dB(A)	94
Equivalent sound pressure level at the operator's ear. See Note 3.	dB(A)	80.4
Cutting attachment		
Cutting diameter	cm (in)	30.5 (12)
Trimmer line diameter	mm (in)	1.65 (0.065)
Feed type		Bump feed line
Unloaded speed	min-1 (RPM)	7,800
Product mass		
Weight (without battery pack)	kg (lb)	2.39 (5.26)
Weight (with battery pack)	kg (lb)	2.79 (6.15)

Note 1: Reported data for equivalent vibration level has a typical statistical dispersion (standard deviation) of 1.5 m/s².

Note 2: Noise emissions in the environment measured as sound power (LWA) in conformity with EC directive 2000/14/EC. Reported sound power level for the machine has been measured with the original cutting attachment that gives the highest level. The difference between guaranteed and measured sound power is that the guaranteed sound power also includes dispersion in the measurement result and the variations between different machines of the same model according to Directive 2000/14/EC.

Note 3: Reported data for equivalent sound pressure level for the machine has a typical statistical dispersion (standard deviation) of 3 dB(A).



Environmental protection

- Waste electrical products should not be disposed of with household waste.
- Please recycle where facilities exist.
- Check with your local authority or retailer for recycling advice.



The following toxic and corrosive materials are in the battery pack: Lithium-Ion

⚠ WARNING: All toxic materials must be disposed of in a specified manner to prevent contamination of the environment. Before disposing of damaged or worn out lithium-ion battery packs, contact your local waste disposal agency, environmental authority, or retailer for information and specific instructions. Take the batteries to a local recycling and/or disposal center, certified for lithium-ion disposal.

CONTENTS OF THE EC DECLARATION OF CONFORMITY

We, Husqvarna AB, SE 561 82 Huskvarna, SWEDEN, declare under our sole responsibility that the represented product:

Description	Grass Trimmer
Brand	Flymo
Platform / Type / Model	Platform IT20BFY, representing model C-Li 20VGT
Batch	Serial number dating 2018 and onwards

complies fully with the following EU directives and regulations:

Directive/Regulation	Description
2006/42/EC	"relating to machinery"
2014/30/EU	"relating to electromagnetic compatibility"
2000/14/EC	"relating to outdoor noise"
2011/65/EU	"relating to hazardous substances"

Harmonized standards and/or technical specifications applied are as follows: EN ISO 12100:2010, EN 60335-1:2012+A13:2017, EN 50636-2-91:2014, EN 62233:2008, EN 55014-1:2017, EN 55014-2:2015

In accordance with directive 2000/14/EC, Annex VI, the declared sound values are stated in the technical data section of this manual and in the signed EC Declaration of Conformity.

Intertek has carried out a voluntary examination on behalf of Husqvarna AB, providing a Certificate of conformity to EC Council directive 2006/42/EC for machinery.

The certificate, as provided on the signed EC Declaration of Conformity, is applicable to all manufacturing locations and Countries of Origin, as stated on the product.

The supplied grass trimmer conforms to the example that underwent examination.

On behalf of Husqvarna AB, SE 561 82 Huskvarna, SWEDEN, 2018-05-10

John Thompson, Product and Marketing Director Responsible for technical documentation

PARTS & ACCESSORIES

Description	Part number
Powerhead	967925200
Battery pack only	967913201
Charger only	967913362 (EU), 967913301 (UK)
Spool and trimmer line complete	591048301

Deutschland / Germany
GARDENA Manufacturing GmbH
Central Service
Hans-Lorenser-Straße 40
D-89079 Ulm
Produktfragen:
(+49) 731 490-123
Reparaturen:
(+49) 731 490-290
service@gardena.com

Albania
COBALT Sh.p.k.
Rr. Sili Kodra
1000 Tirana

Argentina
Husqvarna Argentina S.A.
Av. del Libertador 5954 –
Piso 11 – Torre B
(C1428ARP) Buenos Aires
Phone: (+54) 11 5194 5000
info.gardena@
ar.husqvarna.com

Armenia
Garden Land Ltd.
611 Tigran Mets
0005 Yerevan

Australia
Husqvarna Australia Pty. Ltd.
Locked Bag 5
Central Coast BC
NSW 2252
Phone: (+61) 02 24352 7400
customer.service@
husqvarna.com.au

Austria / Österreich
Husqvarna Austria GmbH
Industriezeile 36
4010 Linz
Tel.: (+43) 732 77 01 01-485
service.gardena@
husqvarnagroup.com

Azerbaijan
Firm Progress
a. Alyev Str. 26A
1052 Baku

Belgium
GARDENA Belgium NV/SA
Sterrebeekstraat 163
1930 Zaventem
Phone: (+32) 2 7 20 92 12
Mail: info@gardena.be

Bosnia / Hercegovina
SILK TRADE d.o.o.
Industrijska zona Bukva bb
74260 Tešanj

Brazil
Husqvarna do Brasil Ltda
Av. Francisco Matarazzo,
1400 – 19º andar
São Paulo – SP
CEP: 05001-903
Tel: 0800-112252
marketing.br.husqvarna@
husqvarna.com.br

Bulgaria
Хусварна България
ЕООД
Бул. „Андрей Ляпчев“ № 72
1799 София
Тел.: (+359) 02/9753076
www.husqvarna.bg

Canada / USA
GARDENA Canada Ltd.
100 Summerlea Road
Brampton, Ontario L6T 4X3
Phone: (+1) 905 792 93 30
info@gardenacanada.com

Chile
Maquinarias Agroforestales
Ltda. (Maga Ltda.)
Santiago, Chile
Avda. Chesterton
8355 comuna Las Condes
Phone: (+56) 2 202 4417
Dalton@мага.cl
Zipcode: 7560330
Temuco, Chile
Avda. Valparaíso # 01466
Phone: (+56) 45 222 126
Zipcode: 4780441

China
Husqvarna (China) Machinery
Manufacturing Co. Ltd.
No. 1355, Jia Xin Rd.,
Ma Lu, Zhen, Jia Ding Dist.,
Shanghai
201801
Phone: (+86) 21 59159629
Domestic Sales
www.gardena.com.cn

Colombia
Husqvarna Colombia S.A.
Calle 18 No. 68 D-31, zona
Industrial de Montevideo
Bogotá, Cundinamarca
Tel. 571 2922700 ext. 105
jairo.salazar@
husqvarna.com.co

Costa Rica
Compania Exim
Euroiberomericana S.A.
Los Colegios, Moravia,
200 metros al Sur del Colegio
Saint Francis – San José
Phone: (+506) 297 68 83
exim_euro@racs.co.cr

Croatia
SILK ADRIA d.o.o.
Josipa Lončara 3
10090 Zagreb
Phone: (+385) 1 3794 580
silk.adria@gz.t-com.hr

Cyprus
Med Marketing
17 Digeni Akrita Ave
P.O. Box 4717
1641 Nicosia

Czech Republic
Husqvarna Cesko s.r.o.
Türkova 2319/5b
149 00 Praha 4 – Chodov
Bezplatná infolinka:
800 100 425
servis@cz.husqvarna.com

Denmark
GARDENA / Husqvarna
Consumer Outdoor Products
Salgscenter Danmark
Box 9003
S-200 39 Malmö
info@gardena.dk
Dominican Republic
BOSQUESA, S.R.L.
Carretera Santiago Licey
Km. 5 ½
Esquina Copal II,
Santiago
Dominican Republic
Phone: (+809) 736-0333
joserbosquesa@claro.net.do

Ecuador
Husqvarna Ecuador S.A.
Arupos E1-181 y 10 de
Agosto Quito, Pichincha
Tel. (+593) 22800739
francisco.jacome@
husqvarna.com.ec

Estonia
Husqvarna Eesti OÜ
Consumer Outdoor Products
Kesk tee 10, Aaviku küla
Rae vald
Harju maakond
75305 Estonia
kontakt.etj@husqvarna.ee

Finland
Oy Husqvarna Ab
Consumer Outdoor Products
Lautatarhankatu 8 B / PL 3
00581 HELSINKI
info@gardena.fi

France
Husqvarna France
9/11 Allée des pierres mayettes
92635 Gennevilliers Cedex
France
http://www.gardena.com/fr
N° AZUR: 0 810 00 78 23
(Prix d'un appel local)

Georgia

ALD Group
Belashvili 8
1159 Tbilisi
Great Britain
Husqvarna UK Ltd
Preston Road
Aycliffe Industrial Park
Newton Aycliffe
County Durham
DL5 6UP
info.gardena@
husqvarna.co.uk

Greece
Π.ΠΑΠΑΔΟΠΟΥΛΟΣ ΑΕΒΕ
Λεωφ. Αθηνών 92
Αθήνα
Τ.Κ.104 42
ΕΛΛΑΔΑ
Τηλ. (+30) 210 5193100
info@papadopoulos.com.gr

Hungary
Husqvarna Magyarország Kft.
Ezred u. 1-3
1044 Budapest
Telefon: (+36) 1 251-4161
vevoszolgalat.husqvarna@
husqvarna.hu

Iceland
Ó. Johnson & Kaaber
Tunguhsalsi 1
110 Reykjavik
ooj@ojk.is

Ireland

Husqvarna UK Ltd
Preston Road
Aycliffe Industrial Park
Newton Aycliffe
County Durham
DL5 6UP
info.gardena@
husqvarna.co.uk

Italy

Husqvarna Italia S.p.A.
Via Como 72
23868 VALMADRERA (LC)
Phone: (+39) 0341.203.111
info@gardenaitalia.it

Japan

KAKIJICHI Co. Ltd.
Sumitomo Realty &
Development Kojimachi
BLDG., 8F
5-1 Nibanncho
Niyoda-ku
Tokyo 102-0084
Phone: (+81) 33 264 4721
m.ishihara@kaku-ichi.co.jp

Kazakhstan
LAMED Ltd.
155/1, Tazhibayevoi LTD.
050060 Almaty
IP Schmidt
Abayavenue 3B
110 005 Kostanay

Korea
Kyung Jin Trading CO.,LTD.
107-4, SunDuk Bld.,
YangJae-dong,
Seocho-gu,
Seoul, (zipcode: 137-891)
Phone: (+82) (0)2 574-6300

Kyrgyzstan
Alye Maki
av. Molodaya Guardir J 3
720014
Bishkek

Latvia

Husqvarna Latvija
Consumer Outdoor Products
Bakūži iela 6
LV-1024 Rīga
info@husqvarna.lv
Lithuania
UAB Husqvarna Lietuva
Consumer Outdoor Products
Atleities pl. 77C
LT-52104 Kaunas
centras@husqvarna.lt

Luxembourg

Magasins Jules Neuberg
39, rue Jacques Stas
Luxembourg-Gasperich 2549
Case Postale No. 12
Luxembourg 2010
Phone: (+352) 40 14 01
api@neuberg.lu

Mexico

AFOSA
Av. Lopez Mateos Sur # 5019
Col. La Calma 45070
Zapopan, Jalisco
Mexico
Phone: (+52) 33 3818-3434
icomejo@afosa.com.mx

Moldova

Convel S.R.L.
290A Muncesti Str.
2002 Chisinau

Netherlands

GARDENA Nederland B.V.
Postbus 50176
1305 AD ALMERE
Phone: (+31) 36 521 00 00
info@nl.gardena.nl
Neth. Antilles
husqva Enterprises N.V.
Sta. Rosa Weg 196
P.O. Box 8200
Curaçao
Phone: (+599) 9 767 66 55
pgrm@onka.com

New Zealand

Husqvarna New Zealand Ltd.
PO Box 76-437
Manukau City 2241
Phone: (+64) (0) 9 9202410
support.nz@husqvarna.com.nz

Norway

GARDENA
Husqvarna Consumer
Outdoor Products
Salgskontor Norge
Klevereivne 6
1540 Vestby
info@gardena.no

Peru

Husqvarna Perú S.A.
Jr. Ramón Cárcamo 710
Lima 1
Tel: (+51) 1 3320400 ext. 416
juan.remuzog@
husqvarna.com

Poland

Husqvarna
Poland Spółka z o.o.
ul. Wysockiego 15 b
03-371 Warszawa
Phone: (+48) 22 330 96 00
gardena@husqvarna.com.pl

Portugal

Husqvarna Portugal, SA
Lagoa - Albarque
2635 - 595 Rio de Mouro
Tel: (+351) 21 922 85 30
Fax: (+351) 21 922 85 36
info@gardena.pt

Romania

Madex International Srl
Soseaua Odaii 117- 123,
RO 0133003 Bucuresti, S1
Phone: (+40) 21 352.76.03
madex@madex.ro

Russia / Россия

ООО „Хусварна“
141400, Московская обл.,
г. Жимла,
улица Ленинградская,
владение 39, стр.6
Бизнес Центр
„Химки Бизнес Парк“,
помещение 0B02_04
http://www.gardena.ru

Serbia

Domel d.o.o.
Autoput za Novi Sad bb
11275 Belgrade
Phone: (+381) 118 48 88 12
miroslav.jejina@domel.rs

Singapore

Hy-Ray PRIVATE LIMITED
40 Jalan Pemimpin
#02-08 Tat Ann Building
Singapore 577185
Phone: (+65) 6253 2277
shying@hyray.com.sg

Slovak Republic

Husqvarna Česko s.r.o.
Türkova 2319/5b
149 00 Praha 4 – Chodov
Bezplatná infolinka:
800 154 044
servis@sk.husqvarna.com

Slovenia

Husqvarna Austria GmbH
Consumer Products
Industriezeile 36
4010 Linz
Tel.: (+43) 732 77 01 01-90
consumer.service@
husqvarna.at

South Africa

Husqvarna
South Africa (Pty) Ltd
Postnet Suite 250
Private Bag X6,
Cascades, 3202
South Africa
Phone: (+27) 33 846 9700
info@gardena.co.za

Spain

Husqvarna España S.A.
C/ Basauri, nº 6
La Florida
28023 Madrid
Phone: (+34) 91 708 05 00
atencioncliente@gardena.es

Suriname

Agrofix n.v.
Verlengde Hogestraat #22
Phone: (+597) 472426
agrofix@sr.net
Pobox : 2006
Paramaribo
Suriname – South America

Sweden

Husqvarna AB
S-561 82 Huskvarna
info@gardena.se

Switzerland / Schweiz

Husqvarna Schweiz AG
Consumer Products
Industriestrasse 10
5506 Mägenwil
Phone: (+41) (0) 62 887 37 90
info@gardena.ch

Turkey

GARDENA Dost Diş Ticaret
Müessesilik A.Ş.
Sanayi Cad. Adı Sokak
No: 1/B Kartal
34873 İstanbul
Phone: (+90) 216 38 93 939
info@gardena-dost.com.tr

Ukraine / Україна

ТОВ «Хусварна Україна»
вул. Васильківська, 34,
офіс 204-г
03022, Київ
Тел: (+38) 044 498 39 02
info@gardena.ua

Uruguay

Uruguay
FEI SA
Entre Rios 1083 CP 11800
Montevideo – Uruguay
Tel: (+598) 212 03 18 44
info@felisa.com.uy

Venezuela

Corporación Casa y Jardín C.A.
Av. Caroní, Edif. Trezmen, PB.
Colinas de Bello Monte,
1050 Caracas.
Tlf: (+58) 212 992 33 22
info@casayjardin.net.ve

Husqvarna AB,
S-561 82
Husqvarna
Sweden





www.flymo.com

Original instructions

114080426-A 2018-07-19